

COAXIAL AND WAVEGUIDE MEASUREMENT ACCESSORIES

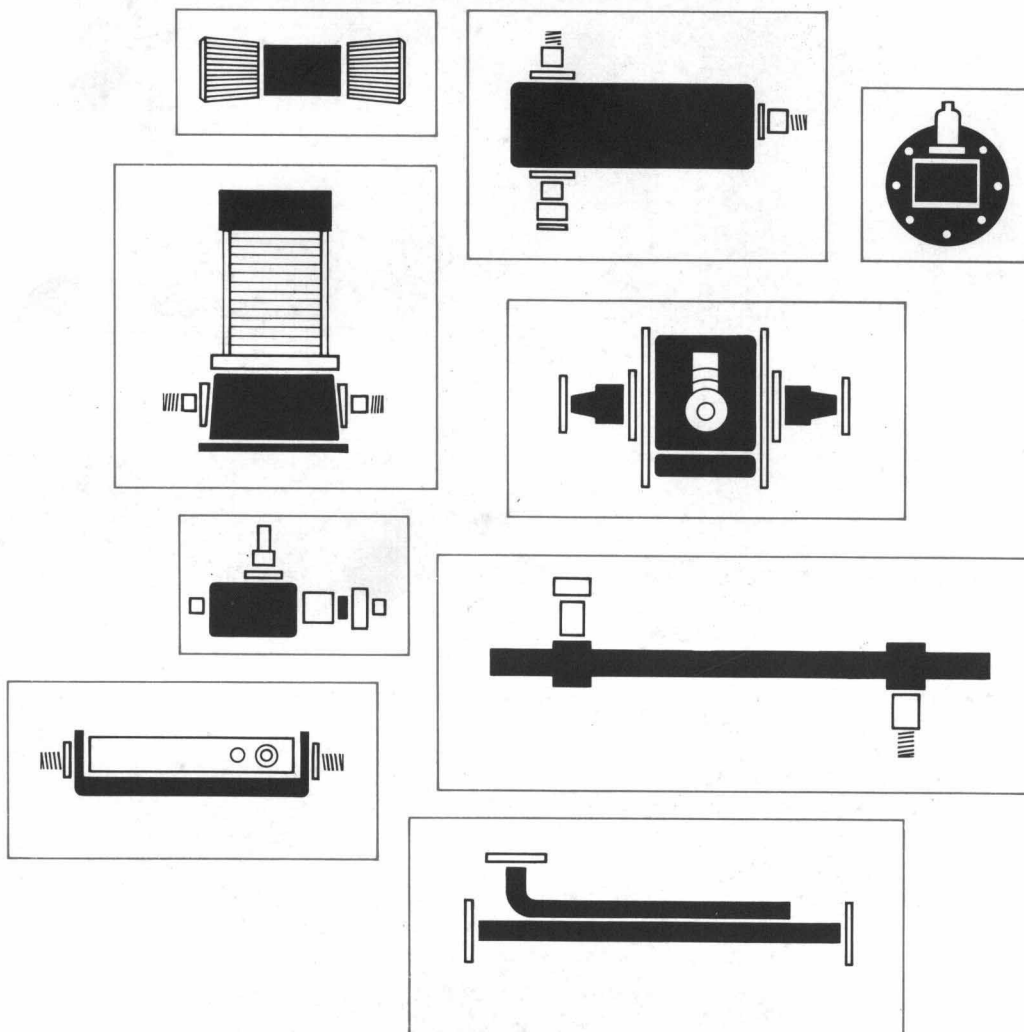



**COAXIAL
AND WAVEGUIDE
MEASUREMENT
ACCESSORIES**



introduction:

The pages that follow contain complete information about Hewlett-Packard's extensive line of high frequency measurement accessories. These coaxial and waveguide products, which enjoy worldwide acceptance for quality and precision, perform significant functions in virtually all high frequency measurement applications. This extensive listing represents but one facet of Hewlett-Packard's total capability.



Hewlett-Packard manufactures more than 2,000 electronic products ranging from basic test instruments to elaborate computational systems. In addition to our state-of-the-art electronic test instruments such as oscillators, voltmeters, counters, and oscilloscopes, HP manufactures computers, scientific calculators, medical electronics, and analytical instruments. HP's high frequency product lines range from microwave devices (e.g., transistors, diodes) and components (e.g., switches, mixers) to multi-function computer-controlled instrumentation systems.

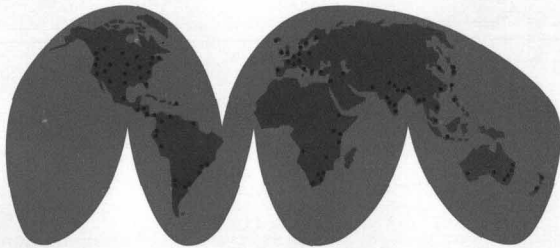

In developing a broad line of state-of-the-art instrumentation, HP has also made numerous contributions to measurement technology. In the area of high frequency measurements, HP has pioneered the use of swept measurements and complete phase/amplitude-characterization of high frequency networks. These were made practical through such development as high directivity multihole directional couplers, precision slotted lines, and rotary vane attenuators. Other high frequency measurement contributions include precision solid-state signal generators and sweepers; fully calibrated spectrum analyzers, and high accuracy power meters. HP's reservoir of measurement technology is available from an extensive library of application notes and video tapes. Direct applications assistance is no further away than the nearest telephone. In addition to 20 domestic and international manufacturing facilities, HP maintains over 170 worldwide sales and service offices in 65 different countries. The field offices are staffed by trained engineers, each of whom has a primary responsibility of helping you solve measurement problems.

The quality of the products described here is the same HP quality that has become a standard in the electronics industry. Each product is designed for high stability, wide applicability, convenient size, and simplest possible operation. Highest quality components and materials are used in construction and utmost care is taken in manufacture. Advanced techniques of swept frequency and computer-controlled testing are used to assure that each item meets or exceeds its specifications.



general information:

HOW TO USE THIS LISTING:

The products being presented have been grouped into thirteen product categories. Each category has convenient index tabs for rapid access. A supplementary HP model number index begins on Page 4. Within each product section waveguide product specifications are shaded in blue to provide visual distinction from the coaxial product listings. The overall summaries (waveguide accessories on page 61 and coaxial items on page 62) indicate, at a glance, the availability of products in any given frequency range.

HOW TO ORDER:

Products should be ordered by name and HP model number. Your Hewlett-Packard field engineer can advise you on the availability of special options or features. Your order should be made out to the Hewlett-Packard Company and sent to the nearest Hewlett-Packard field office.

PROCESSING AND SHIPMENT OF YOUR ORDER:

Hewlett-Packard's customer commitment extends to efficient order processing. From any point in our worldwide organization, orders are transmitted daily over special communication lines directly to the appropriate manufacturing facility. Most of the items listed here are available for same-day shipment.

WARRANTY:

These Hewlett-Packard products are all warranted against defects in materials and workmanship for one year from the date of delivery. We will repair or replace products which prove to be defective during the warranty period.



contents

MICROWAVE MEASURING TECHNIQUES

DIRECTIONAL COUPLERS AND DETECTORS

SLOTTED LINE EQUIPMENT AND SLIDE SCREW TUNERS

ATTENUATORS; FIXED, VARIABLE, AND PROGRAMMABLE

FREQUENCY METERS

CRYSTAL DETECTORS

MIXERS

FILTERS

MODULATORS

OTHER DEVICES

PHASE SHIFTERS
 WAVEGUIDE SHORTING SWITCH
 COAXIAL SWITCHES
 FREQUENCY DOUBLER

TERMINATIONS

ACCESSORIES

INSTRUMENTATION CROSS REFERENCE

index

MODEL NUMBER		PAGE	PRICE
G281A	Coaxial-Waveguide Adapter	54	\$60
H281A	Coaxial-Waveguide Adapter	54	50
J281A	Coaxial-Waveguide Adapter	54	55
S281A	Coaxial-Waveguide Adapter	54	75
X281A	Coaxial-Waveguide Adapter, N (f) conn.	54	45
X281B	Coaxial-Waveguide Adapter, APC-7 conn.	54	90
	Opt. 013 Precision N (f) conn.		15
P281B	Coaxial-Waveguide Adapter	54	95
X281B	Coaxial-Waveguide Adapter	54	90
NK292A	Waveguide-Waveguide Adapter	54	60
NP292A	Waveguide-Waveguide Adapter	54	60
HX292B	Waveguide-Waveguide Adapter	54	60
MP292B	Waveguide-Waveguide Adapter	54	80
MX292B	Waveguide-Waveguide Adapter	54	70
354A	Step Attenuator	23	390
355C	Step Attenuator	23	160
	Opt. 001 N(f) conn.		25
355D	Step Attenuator	23	160
	Opt. 001 N (f) conn.		25
360A	Coaxial Low Pass Filter	40	115
360B	Coaxial Low Pass Filter	40	105
360C	Coaxial Low Pass Filter	40	95
360D	Coaxial Low Pass Filter	40	90
K362A	Waveguide Low Pass Filter	40	385
M362A	Waveguide Low Pass Filter	40	350
P362A	Waveguide Low Pass Filter	40	375
R362A	Waveguide Low Pass Filter	40	420
X362A	Waveguide Low Pass Filter	40	450
P375A	Waveguide Variable Attenuator	27	250
X375A	Waveguide Variable Attenuator	27	225
G382A	Waveguide Precision Variable Attenuator		810
H382A	Waveguide Precision Variable Attenuator	27	675
J382A	Waveguide Precision Variable Attenuator	28	700
K382A	Waveguide Precision Variable Attenuator	27	725
P382A	Waveguide Precision Variable Attenuator	27	500
R382A	Waveguide Precision Variable Attenuator	27	800
S382C	Waveguide Precision Variable Attenuator	27	800
X382A	Waveguide Precision Variable Attenuator	27	425
393A	Coaxial Variable Attenuator	23	725
	Opt. 001 Less 908A Terminations		- 70
394A	Coaxial Variable Attenuator	23	725
	Opt. 001 Less 908A Terminations		-70
420A	Coaxial Crystal Detector	32	65

MODEL NUMBER		PAGE	PRICE
420B	Coaxial Crystal Detector	32	\$95
	Opt. 001 matched pair		10
K422A	Waveguide Crystal Detector	33	350
	Opt. 001 matched pair		40
	Opt. 002 Opt. sq. law characteristics		20
R422A	Waveguide Crystal Detector	33	350
	Opt. 001 matched pair		40
	Opt. 002 Opt. Sq. Law Characteristics		20
423A	Coaxial Crystal Detector	32	150
G424A	Waveguide Crystal Detector	33	200
H424A	Waveguide Crystal Detector	33	190
J424A	Waveguide Crystal Detector	33	200
M424A	Waveguide Crystal Detector	33	290
P424A	Waveguide Crystal Detector	33	210
S424A	Waveguide Crystal Detector	33	210
X424A	Waveguide Crystal Detector	33	170
	The following options apply to 423A-X424A:		
	Opt. 001 Matched Pair		20
	Opt. 002 Opt. Sq. Law Characteristics		20
	Opt. 003 Positive Polarity Output		0
440A	Detector Mount	32	125
442B	Slotted Line RF Probe	20	60
444A	Slotted Line Detector	20	65
446B	Slotted Line Detector	20	275
447B	Slotted Line Detector	20	125
448A	Slotted Line Sweep Adapter	20	400
X485B	Waveguide Detector Mount	32	150
H532A	Waveguide Frequency Meter	30	650
J532A	Waveguide Frequency Meter	30	550
K532A	Waveguide Frequency Meter	30	525
P532A	Waveguide Frequency Meter	30	350
R532A	Waveguide Frequency Meter	30	525
X532B	Waveguide Frequency Meter	30	325
536A	Coaxial Frequency Meter	30	600
537A	Coaxial Frequency Meter	30	525
H752A	Waveguide Directional Coupler	14	300
J752A	Waveguide Directional Coupler	14	400
K752A	Waveguide Directional Coupler	14	275
P752A	Waveguide Directional Coupler	14	225
R752A	Waveguide Directional Coupler	14	300
X752A	Waveguide Directional Coupler	14	200
H752C	Waveguide Directional Coupler	14	300
J752C	Waveguide Directional Coupler	14	400
K752C	Waveguide Directional Coupler	14	275

MODEL NUMBER		PAGE	PRICE
P752C	Waveguide Directional Coupler	14	\$ 225
R752C	Waveguide Directional Coupler	14	300
X752C	Waveguide Directional Coupler	14	200
H752D	Waveguide Directional Couler	14	300
J752D	Waveguide Directional Coupler	14	400
K752D	Waveguide Directional Coupler	14	275
P752D	Waveguide Directional Coupler	14	225
R752D	Waveguide Directional Coupler	14	300
X752D	Waveguide Directional Coupler	14	200
774D	Coaxial Dual Directional Coupler	13	300
775D	Coaxial Dual Directional Coupler	13	325
776D	Coaxial Dual Directional Coupler	13	325
777D	Coaxial Dual Directional Coupler	13	350
778D	Coaxial Dual Directional Coupler	13	450
	Opt. 011 APC-7 Output Conn.		25
	Opt. 012 N (m) Output Conn.		0
779D	Coaxial Directional Coupler	13	550
	Opt. 010 Input N(f), output N(m)		0
784A	Coaxial Directional Detector	15	625
786D	Coaxial Directional Detector	15	300
787D	Coaxial Directional Detector	15	325
788C	Coaxial Directional Detector	15	350
789C	Coaxial Directional Detector	15	550
	The following options apply to 786D-789C:		
	Opt. 002 Opt. Sq. Law Characteristics		20
	Opt. 003 Positive Polarity Output		0
796D	Coaxial Directional Coupler	13	275
797D	Coaxial Directional Coupler	13	300
798C	Coaxial Directional Coupler	13	325
805C	Coaxial Slotted Line	19	1000
809C	Universal Carriage	20	300
H810B	Waveguide Slotted Section	19	215
J810B	Waveguide Slotted Section	19	275
P810B	Waveguide Slotted Section	19	225
X810B	Waveguide Slotted Section	19	205
814B	Carriage	20	660
K815B	Waveguide Slotted Section	19	675
R815B	Waveguide Slotted Section	19	700
816A	Coaxial Slotted Section	19	350
	Opt. 011 Two APC-7 Conn.		25
	Opt. 022 N(m) and N(f) Conn.		-15
817A	Coaxial Swept Slotted Line System	20	1100
	Opt. 022 N(m) and N(f) Conn.		-15
P870A	Waveguide Slide Screw Tuner	19	275

MODEL NUMBER		PAGE	PRICE
X870A	Waveguide Slide Screw Tuner	19	\$250
J885A	Waveguide Phase Shifter	46	950
P885A	Waveguide Phase Shifter	46	900
X885A	Waveguide Phase Shifter	46	725
905A	Coaxial Sliding Load	51	300
907A	Coaxial Sliding Load	51	450
908A	Coaxial Termination	51	45
909A	Coaxial Termination	51	85
	Opt. 012 N(m) Conn.		-15
	Opt. 013 N(f) Conn.		-15
H910A	Waveguide Termination	50	80
J910A	Waveguide Termination	50	95
P910A	Waveguide Termination	50	50
X910B	Waveguide Termination	50	55
911A	Coaxial Sliding Load	51	250
G914A	Waveguide Sliding Load	50	250
H914A	Waveguide Sliding Load	50	200
J914A	Waveguide Sliding Load	50	225
P914A	Waveguide Sliding Load	50	175
K914B	Waveguide Sliding Load	50	350
R914B	Waveguide Sliding Load	50	400
X914B	Waveguide Sliding Load	50	95
H920A	Waveguide Moving Short	50	165
J920A	Waveguide Moving Short	50	200
K920B	Waveguide Moving Short	50	325
P920B	Waveguide Moving Short	50	190
R920B	Waveguide Moving Short	50	350
X923A	Waveguide Sliding Short	50	150
X930A	Waveguide Shorting Switch	47	300
P932A	Waveguide Harmonic Mixer	37	350
934A	Coaxial Harmonic Mixer	37	150
3750A	75 Ohm Coaxial Variable Step Attenuator	23	165
8430A	Bandpass Filter	40	335
8431A	Bandpass Filter	40	335
8432A	Bandpass Filter	40	335
8433A	Bandpass Filter	40	335
8434A	Bandpass Filter	40	335
8435A	Bandpass Filter	40	335
8436A	Bandpass Filter	40	335
8439A	Notch Filter	40	450
8470A	Coaxial Crystal Detector	32	190
8471A	Coaxial Crystal Detector	32	50
8472A	Coaxial Crystal Detector	32	175
8491A	(3-30dB) Coaxial Fixed Attenuator	25	60

MODEL NUMBER		PAGE	PRICE
8491A	(40-60 dB) Coaxial Fixed Attenuator	25	\$85
8491B	(3-30 dB) Coaxial Fixed Attenuator	25	75
8491B	(40-60 dB) Coaxial Fixed Attenuator	25	110
8492A	(3-30dB) Coaxial Fixed Attenuator	25	140
8492A	(40-60 dB) Coaxial Fixed Attenuator	25	175
8493A	Coaxial Fixed Attenuator	25	65
8493B	Coaxial Fixed Attenuator	25	80
8721A	Coaxial Directional Bridge	15	150
	Opt. 008 75 ohm Version		10
8731A	Pin Modulator	42	450
8731B	Pin Modulator	42	700
	Opt. H10 0.4-0.9 GHZ, 35 dB		0
8732A	Pin Modulator	42	450
8732B	Pin Modulator	42	700
8733A	Pin Modulator	42	450
8733B	Pin Modulator	42	700
8734A	Pin Modulator	42	450
8734B	Pin Modulator	42	700
8735A	Pin Modulator	43	450
8735B	Pin Modulator	43	700
8761A/B	Coaxial Switch	47	150
	Opt. 7XX APC-7 Conn.		35
	Opt. X7X APC-7 Conn.		35
10501A	Cable Assembly	56	8
10502A	Cable Assembly	56	12
10503A	Cable Assembly	56	13
10514A	Double Balanced Mixer	36	90
10515A	Frequency Doubler	48	150
10534A	Double Balanced Mixer	36	70
11500A	Cable Assembly	56	20
11501A	Cable Assembly	56	20
11503A	Flexible Waveguide	57	60
11504A	Flexible Waveguide	57	50
11511A	Short, N(f)	51	10
11512A	Short, N(m)	51	10
11515A	Adapter, K-band	54	60
11516A	Adapter, R-band	54	50
11517A	Waveguide Mixer	37	200
11518A	Mixer Taper Section	37	125
11519A	Mixer Taper Section	37	125
11520A	Mixer Taper Section	37	125
11521A	Waveguide Mixer	37	75
11540A	Waveguide Stand	55	10

MODEL NUMBER		PAGE	PRICE
11542A-11548A	Waveguide Clamps	55	\$ 5
11565A	Short, APC-7	51	25
11581A	Attenuator Set, 8491A	25	250
11582A	Attenuator Set, 8491B	25	310
11583A	Attenuator Set, 8492A	25	575
11588A	Coaxial Rotary Joint	56	200
11589A	Bias Network	59	275
	Opt. 001 APC-7 Conn.		30
11590A	Bias Network	59	325
	Opt. 001 APC-7 Conn.		30
11591A	APC-7 Connector Service Kit	59	60
11600B	Transistor Fixture	58	600
	Opt. 001 Precision N(f) Conn.		-30
11602B	Transistor Fixture	58	600
	Opt. 001 Precision N(f) Conn.		-30
11605A	Flexible Arm	57	800
11606A	Coaxial Rotary Air Line	56	150
11608A	Transistor Fixture, (opt 001)	58	375
	Opt. 100 N(f) Conn.		-30
11608A	Transistor Fixture, (opt 002, 003)	58	400
	Opt. 100 N(f) Conn.		-30
11675A	Leveling Cable Assembly	57	50
15520A	Hybrid	15	105
	Opt. 002 Siemens 2.5 mm Conn.		51
	Opt. 003 Siemens 1.6 mm Conn.		51
15522A	75 Ohm Termination	51	36
	Opt. 002 Siemens 2.5 mm Conn.		0
	Opt. 003 Siemens 1.6 mm Conn.		0
15537A	Hybrid	15	115
33000C	Absorptive Modulator	43	365
33000D	Absorptive Modulator	43	525
33001C	Absorptive Modulator	43	415
33001D	Absorptive Modulator	43	575
33008C	Absorptive Modulator	43	395
33008D	Absorptive Modulator	43	550
33300A/B	Programmable Step Attenuators	23	665
33300C/D	Programmable Step Attenuators	23	690
33301A/B	Programmable Step Attenuators	23	665
33301C/D	Programmable Step Attenuators	23	690
33304A/B	Programmable Step Attenuators	23	900
33304C/D	Programmable Step Attenuators	23	925
33305A/B	Programmable Step Attenuators	23	900
33305C/B	Programmable Step Attenuators	23	925

microwave measuring techniques

Hewlett-Packard offers a complete line of microwave test equipment from which systems can be assembled for making accurate reflection, transmission and frequency measurements. Equipment ranges from inexpensive CW systems which measure a magnitude response to powerful network analyzers which furnish a dynamic CRT display of frequency swept magnitude and phase. Measurement techniques and equipment functions are discussed briefly in the following paragraphs. More detailed information is available in Application Notes 64, 65, and 84, complimentary copies are available from Hewlett-Packard sales offices.

FREQUENCY MEASUREMENTS

There are two general classes of frequency measuring devices—active and passive types. Electronic counters, transfer oscillators, and frequency converters are examples of active types. HP manufactures a complete line of these instruments which measure frequency well into the microwave region with accuracies of a few parts in 10^8 .

Where the accuracy of active devices is not required, passive devices offer direct readout at a considerable saving in cost. Passive transmission-type frequency meters, such as the HP 532, 536A, and 537A, are two-port devices that absorb part of the input power in a tunable cavity. When the cavity is tuned to resonance, a dip occurs in the transmitted power level. This dip can be observed on a meter or oscilloscope display of the detected RF voltage. Frequency is then read from a calibrated dial driven by the cavity tuning mechanism.

The accuracy of cavity frequency meters depends upon the cavity Q, dial calibration, backlash, and effects of temperature and humidity variations. The Hewlett-Packard waveguide and coaxial passive frequency meters achieve accuracies of a few parts in 10^4 .

IMPEDANCE MEASUREMENTS

Impedance-matching a load to its source is one of the most important considerations in microwave transmission systems. If the load and source are mismatched, part of the power is reflected back along the transmission line toward the source. This reflection not only limits maximum power transfer, but also can be responsible for erroneous measurements of other parameters or even cause circuit damage in high-power applications.

The signal reflected from the load interferes with the incident (forward) signal, causing standing waves of voltage and current along the line. SWR which is the ratio of standing wave maxima to minima is directly related to the impedance mismatch of the load. The standing wave ratio (SWR), therefore, provides a valuable means of determining impedance magnitude and mismatch.

There are two common methods for measuring

SWR; slotted line techniques and reflectometer techniques. A slotted line measures the ratio of standing wave maxima to minima while a reflectometer separates the incident and reflected voltage waves and then measures their ratio.

Slotted Line Techniques—Single Frequency

Standing-wave ratio can be measured directly with a slotted line in a setup like the one shown in Figure 1. The slotted line probe is loosely coupled to the RF field in the line, thus sensing relative amplitudes of the standing-wave pattern as the probe is moved along the line. The ratio of maxima to minima (SWR) is displayed directly on the SWR meter.

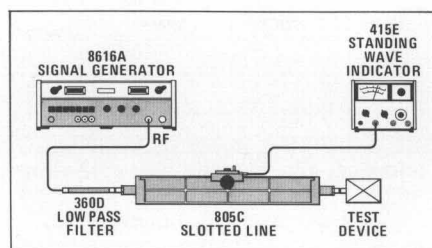

FIGURE 1. Typical setup for SWR measurements in coax.

Slotted lines feature low residual SWR (high directivity) and have the capability of inexpensive phase measurements compared to reflectometer techniques. While these methods work well for single-frequency testing, they are time-consuming for broadband applications.

The Swept Slotted Line

A measuring system which combines the speed and convenience of swept-frequency measurements and the inherent accuracy of the slotted line can be built around the HP 817A Slotted Line System. The setup is identical to Figure 1 except that the source is replaced with a sweep oscillator, the slotted line is an 817A option H03, and the 415E is replaced by the HP 8755A/181A. This system will operate throughout the frequency range from 1.8

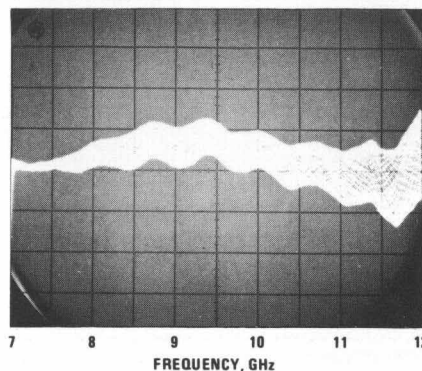

Figure 2. Multi-sweep slotted-line measurement. Vertical scale 0.5 dB/cm.



microwave measuring techniques continued

to 18 GHz. The measurement results are displayed on a storage oscilloscope as an envelope of the SWR in dB. See Figure 2. At any given frequency, the ratio of the maximum and minimum amplitude of the envelope is the SWR. A plot of SWR can be generated in a few seconds and retained on the CRT for evaluation or photography. Accuracy of slotted-line measurements is limited primarily by the residual SWR of the line itself, 1.01 in waveguide and 1.02 to 1.06 in coax depending upon the frequency and type of connector.

Reflectometer techniques

The reflection coefficient (ρ) of a device or system is another useful term in establishing the impedance match of microwave devices. The following relationships of ρ and SWR are frequently used in impedance work:

$$\rho = \frac{|E_{\text{reflected}}|}{|E_{\text{incident}}|} = \frac{\text{SWR}-1}{\text{SWR}+1}$$

Reflection coefficient (ρ) is a linear quantity varying between zero and one. The logarithmic expression of ρ is known as return loss and defined as: $\text{dB} = -20 \text{Log}_{10} |\rho|$. A reflection coefficient of 1.0 (total reflection) therefore, corresponds to a return loss of 0 dB and a zero reflection coefficient corresponds to infinite dB return loss. For example, if the reflected signal from a test device is 26 dB below the incident signal level, the reflection coefficient of the device is calculated as 0.05.

The load reflection coefficient is measured by separating the incident and reflected waves propagated in the transmission line connecting the source and load. The reflectometer uses either coaxial or waveguide couplers to accomplish this separation. Reflectometers permit dynamic oscilloscope displays or permanent X-Y recordings of reflection coefficient or return loss across complete operating bands.

The waveguide reflectometer setup shown in Figure 3 is designed to hold the incident power constant by leveling. With automatic leveling, only the relative amplitude of the reflected wave need be measured to determine reflection coefficient.

To calibrate the reflectometer, a short circuit is placed at the output port, thus reflecting all of the incident power (zero dB return loss). The detector in the reverse-arm coupler samples the reflected power and provides a proportional dc voltage for readout. By placing a calibrated attenuator ahead of the detector specific amounts of return loss may be pre-inserted for calibrating the recorder gain. The attenuator is then returned to zero, the short removed, and the test device connected and measured on the pre-calibrated display. Measurements are also possible without the pre-insertion attenuator if the detector remains within its square law region.

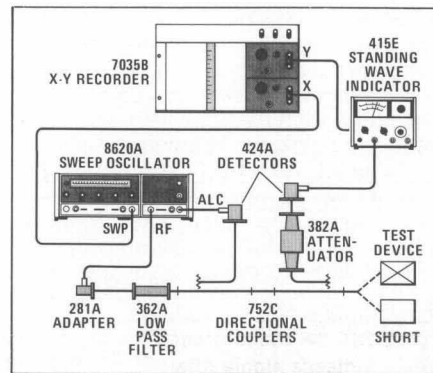

FIGURE 3. Typical waveguide reflectometer.

The reflectometer technique described is an economical way for making swept measurements (See HP Application Note 65 for more information). However, greater speed and convenience is possible with the HP 8755 Series Frequency Response Test Sets. These sets make precision measurements of return loss (SWR) over a continuous 60 dB dynamic range compared to the 25 dB square law range of most crystal detectors. Measured data can be either plotted on an X-Y recorder or read directly from a fully calibrated CRT display. See Figure 5 and Hewlett-Packard Application Note 155.

Accuracy of reflectometer measurements is limited by directional coupler directivity. A residual SWR of 1.02 (40 dB directivity) is common in waveguide and 1.02 to 1.1 in coax depending on the frequency range and connectors.

ATTENUATION MEASUREMENTS

Attenuation is defined as the decrease in power (at the load) caused by inserting a device between a Z_0 source and load. Under this condition, the measured value is a property of the device alone. The term Z_0 is used to describe a unity SWR condition where the load and source impedances equal the transmission line impedance.

There are three common methods for measuring RF attenuation: 1) square-law detection with audio substitution, 2) direct RF substitution, and 3) linear detection with IF substitution. Accurate square-law measurements and RF substitution are possible using crystal detectors such as the HP 423A coaxial, and 424A waveguide series.

Square-law detection technique

Figure 4 shows a waveguide system for swept attenuation measurements of 25 to 30 dB. Source power is leveled using a single 752-series 10 dB directional coupler in the ALC loop. Coupling variation versus frequency in the leveling loop causes leveled power variations of about 1 dB at the point of test device insertion. This power variation is

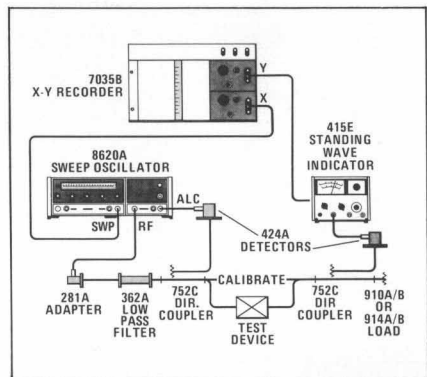

FIGURE 4. Swept attenuation system for measurements up to 30 dB.

nearly equal to, but opposite, the coupling variation of the readout coupler. Therefore, grid lines are plotted to remove the frequency response error and increase measurement resolution.

With the 8620A sweeping the frequency range of interest, a zero-dB reference level is established on the x-y recorder without the test device in the system. The device is then inserted as indicated in Figure 4 and its attenuation versus frequency determined by the amplitude decrease from the reference level previously established.

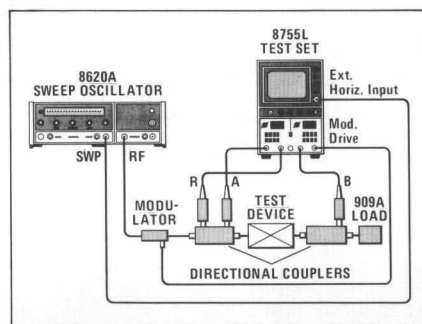

FIGURE 5. Setup for simultaneous swept measurement of insertion gain/loss and return loss.

A much improved square-law detection technique uses the HP 8755L Frequency Response Test Set. The setup diagram in Figure 5 permits simultaneous measurements of attenuation and return loss over a continuous 60 dB dynamic range. Readout is either on a CRT display calibrated directly in dB or a X-Y recorder. The 8755A is plug-in compatible with the 180 Series oscilloscopes and has a frequency range of 100 MHz to 18 GHz.

RF substitution technique

Swept attenuation measurements up to 45 to 50 dB can be made using the RF pre-insertion, X-Y recorder system shown in Figure 6. Coupler tracking and detector errors are eliminated by plotting a calibration grid on the X-Y recorder prior to the actual measurement. The grid is plotted by setting in specific values of attenuation

on the 382A near the anticipated test device attenuation and triggering single 30-second sweeps. The 382A is then set to 0 dB and the test device inserted as shown in Figure 6. A final sweep plots attenuation of the test device over the calibration grid.

IF substitution technique

The IF substitution technique of attenuation measurement involves conversion of the microwave frequency to a constant, much lower frequency for which very accurately calibrated attenuators are available. Detection at a constant IF frequency improves the system sensitivity permitting measurements over a wide (>60 dB) dynamic range. Both the HP 8405A Vector Voltmeter and HP 8410A Network Analyzer shown on page 10 use these IF signal processing techniques. The 8405A measures the absolute level of two signals and the phase difference between them on a CW basis from 1 to 1000 MHz. Phase accuracy is 1.5 to 3.0 degrees and voltage accuracy $\pm 2\%$ to $\pm 6\%$ of full scale depending on the frequency and amplitude range settings.

The 8410 Family of instruments display amplitude and phase information of reflection coefficient, return loss, attenuation, or gain on a swept frequency basis in the range from 110 MHz to 40 GHz. The 8410 Family includes a complete set of test sets for making both waveguide and coaxial component measurements over a continuous 60 dB dynamic range. This equipment features a maximum IF attenuator accuracy of ± 2 dB and a dynamic CRT display of all measured quantities. Compared to a slotted line these systems have a much improved accuracy and readout of phase information. Compared to the other techniques mentioned in this section they offer the latest in speed, measurement precision, and user convenience.

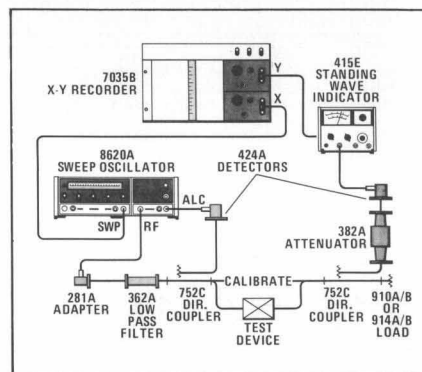

FIGURE 6. RF pre-insertion technique for swept attenuation measurements.



associated instruments



8405A Vector Voltmeter—The 8405A tuned voltmeter measures the absolute level of two signals and the phase difference between them on a CW basis from 1 MHz to 1000 MHz.

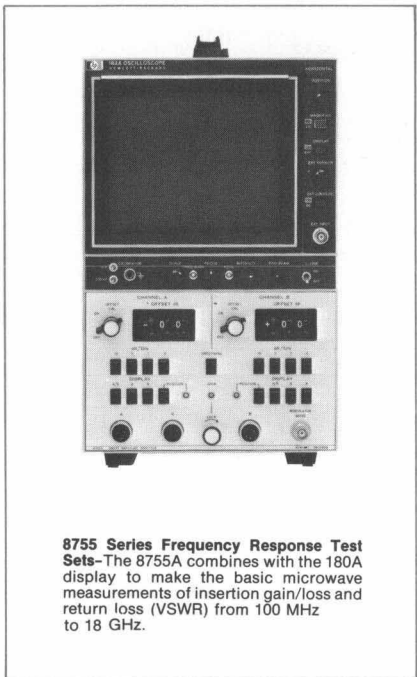

8755 Series Frequency Response Test Sets—The 8755A combines with the 180A display to make the basic microwave measurements of insertion gain/loss and return loss (VSWR) from 100 MHz to 18 GHz.

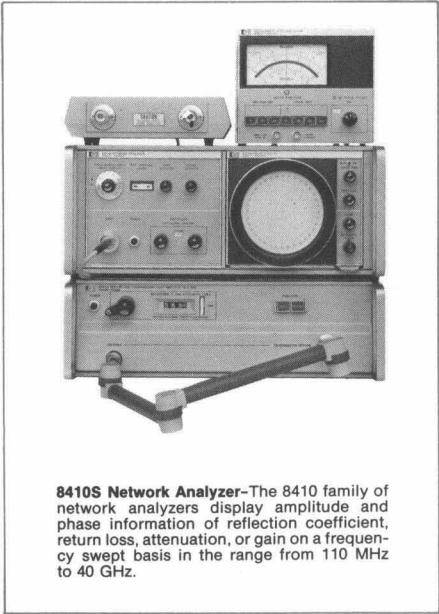

8410S Network Analyzer—The 8410 family of network analyzers display amplitude and phase information of reflection coefficient, return loss, attenuation, or gain on a frequency swept basis in the range from 110 MHz to 40 GHz.

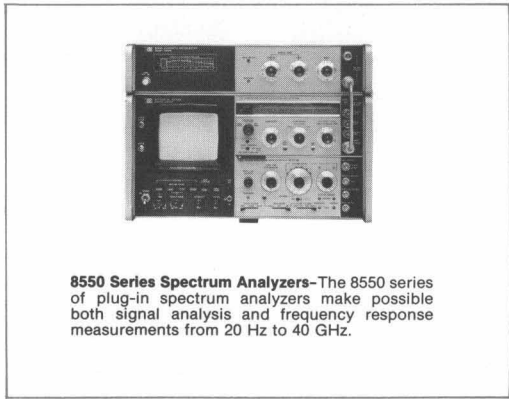

8550 Series Spectrum Analyzers—The 8550 series of plug-in spectrum analyzers make possible both signal analysis and frequency response measurements from 20 Hz to 40 GHz.

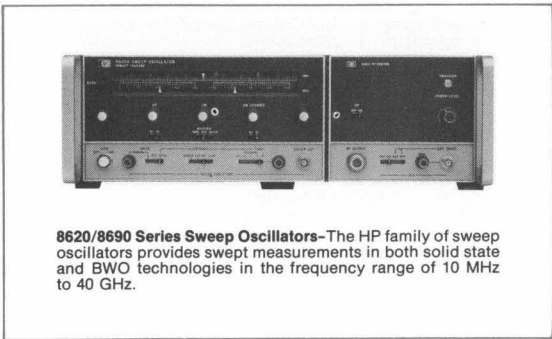

8620/8690 Series Sweep Oscillators—The HP family of sweep oscillators provides swept measurements in both solid state and BWO technologies in the frequency range of 10 MHz to 40 GHz.

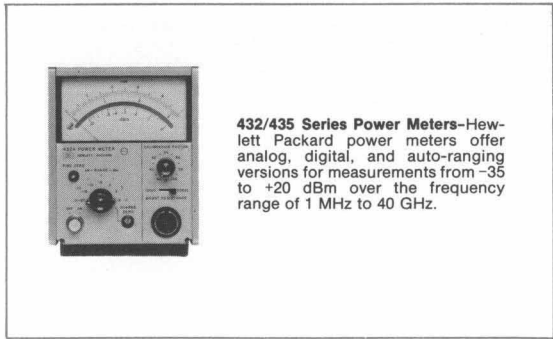

432/435 Series Power Meters—Hewlett Packard power meters offer analog, digital, and auto-ranging versions for measurements from -35 to +20 dBm over the frequency range of 1 MHz to 40 GHz.



features:

HIGH DIRECTIVITY
FLAT FREQUENCY RESPONSE
LOW SWR
LOW INSERTION LOSS
WIDE FREQUENCY COVERAGE
HIGH POWER HANDLING CAPABILITY

applications:

Power Monitoring
Power Leveling
Frequency Monitoring
Reflection Coefficient (SWR) Measuring
Impedance Measuring

DIRECTIONAL COUPLERS



DIRECTIONAL COUPLERS
AND DETECTORS

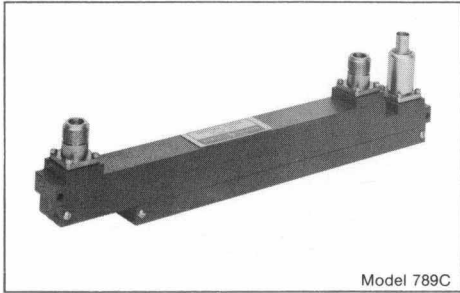

Model 789C

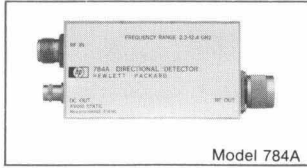

Model 784A

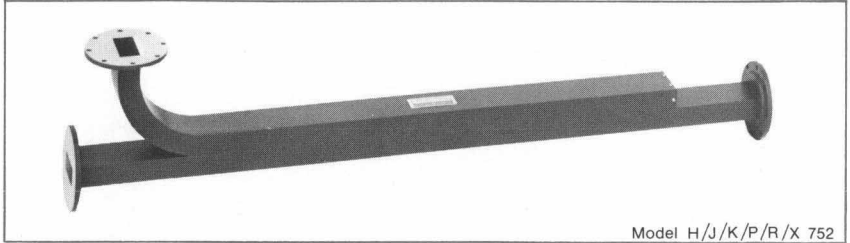

Model H/J/K/P/R/X 752

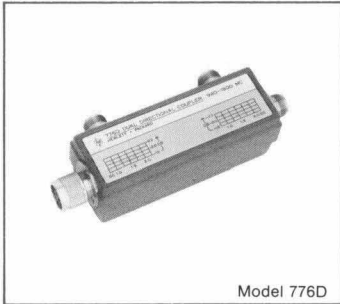

Model 776D

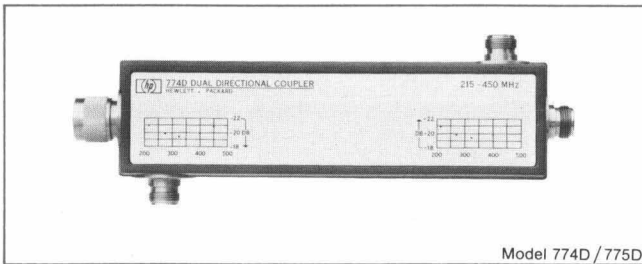

Model 774D/775D

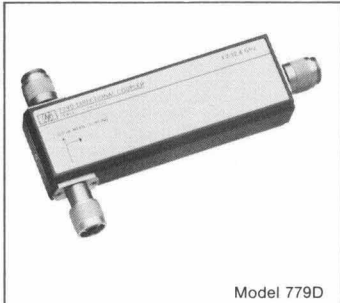

Model 779D

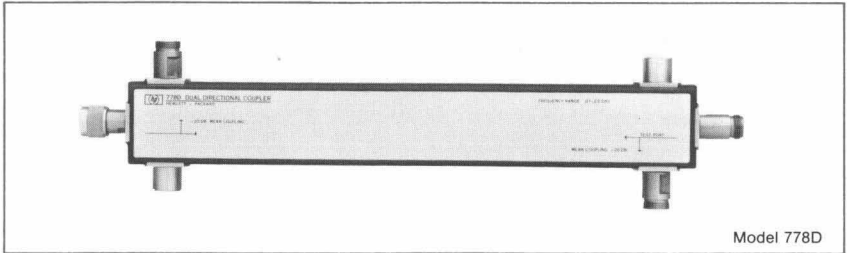

Model 778D



Model 786D/787D/788C

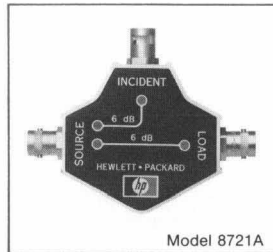

Model 8721A

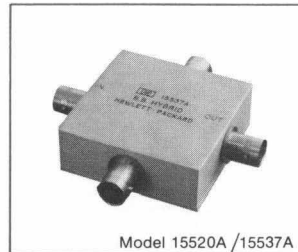

Model 15520A/15537A

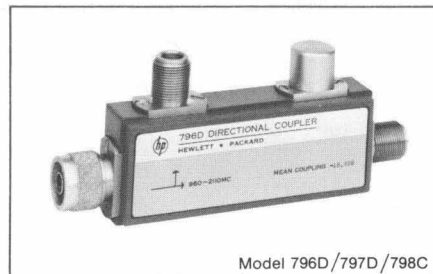

Model 796D/797D/798C



SPECIFICATIONS

Model:	DUAL DIRECTIONAL COUPLERS					DIRECTIONAL COUPLERS			
	774D	775D	776D	777D	778D	779D	796D	797D	798C
Frequency Range (GHz):	.215-450	.450-.940	.940-1.900	1.900-4.000	.100-2.000	1.7-12.4	.96-2.11	1.9-4.1	3.7-8.3
Nominal Coupling (dB)*:	20	20	20	20	20	20	20	20	10
Mean Coupling Accuracy (dB):	± 0.5	± 0.5	± 0.5	± 0.5		± 0.5	± 0.5	± 0.5	± 0.3
Maximum Coupling † Variation (dB):	± 1	± 1	± 1	± 0.4	± 1	± 0.75	± 0.2	± 0.2	± 0.3
Minimum Directivity (dB):	40	40	40	30	36, 0.1-1 GHz 32, 1-2 GHz (test port)	30, 1.7-4 GHz 26, 4-12.4 GHz	30	26	20
Maximum Primary Line SWR:	1.15	1.15	1.15	1.2	1.1	1.2	1.13	1.16	1.25
Maximum Auxiliary Arm SWR:	1.20	1.20	1.20	1.25	1.1	1.2	1.20	1.25	1.20
Maximum Auxiliary Arm Tracking (dB):			0.3	0.5	0.7 (4° Phase)				
Primary Line Power Handling Capability:	50 W ave. 500 W peak‡	50 W ave. 500 W peak‡	50 W ave. 500 W peak‡	50 W ave. 500 W peak‡	50 W ave. 500 W peak‡	50 W ave. 500 W peak‡	50 W ave.	50 W ave.	10 W ave.
Auxiliary Arm Load Average Power:	0.5 W	0.5 W	0.5 W	0.5 W	0.5 W	2 W	0.5 W	0.5 W	0.5 W
Maximum Primary Line Residual Loss (dB):	0.30	0.40	0.35	0.75	1.5	0.5	0.4	0.5	0.8
Primary Line/Auxiliary Arm Connectors:	"N"(m,f)/ "N"(f,f)	"N"(m,f)/ "N"(f,f)	"N"(m,f)/ "N"(f,f)	"N"(m,f)/ "N"(f,f)	"N"(m,f)/ "N"(f,f)	"N"(m,f)/ "N"(f)	"N"(m,f)/ "N"(f)	"N"(m,f)/ "N"(f)	"N"(m,f)/ "N"(f)
Dimensions (in/mm):	9 ¹ / ₁₆ x3 ³ / ₁₆ x1 ³ / ₄ 230x70x45	9 ¹ / ₁₆ x3 ³ / ₁₆ x1 ³ / ₄ 230x70x45	6 ⁵ / ₁₆ x2 ⁵ / ₁₆ x1 ³ / ₄ 161x59x45	8 ⁷ / ₁₆ x2 ⁷ / ₁₆ x1 ¹ / ₂ 225x64x29	16 ³ / ₁₆ x4 ³ / ₁₆ x1 ³ / ₁₆ 425x111x30	7 ³ / ₁₆ x4 ¹ / ₂ x1 196x114x26	6x1 ¹ / ₁₆ x2 ⁷ / ₁₆ 152x29x62	4 ⁷ / ₁₆ x1 ¹ / ₁₆ x2 ⁷ / ₁₆ 124x29x62	4 ⁷ / ₁₆ x1 ¹ / ₁₆ x3 ³ / ₁₆ 124x29x99
Weight (lbs/kg):	Net 3/1,4 Shipping 4/1,8	3/1,4 4/1,8	2/0,9 3/1,4	2/0,9 3/1,4	3 ³ / ₁₆ /1,5 5/2,3	1 ³ / ₁₆ /0,75 3/1,4	1/0,45 2/0,9	1/0,45 2/0,9	1/0,45 2/0,9
Options Available:					011, 012	010, (APC)			

* Nominal Coupling, Coupling Factor, Coupling Attenuation are terms that describe the same parameter.

† Specification if for Frequency Response.

◇ 30 dB, 0.1-2 GHz, to input port auxiliary arm.

‡ 0.1 sec duty cycle.

Options: 010 N female input connector, N male output connector, N female auxiliary connector.

011 APC-7 output connector, N female input connectors.

012 N male output connector, N female input connectors.

(APC) APC-7 connectors on any (or all) port(s) on special order.



SPECIFICATIONS

DIRECTIONAL COUPLERS

	Model: J752			H752			X752			P752			K752			R752					
	A	C	D	A	C	D	A	C	D	A	C	D	A	C	D	A	C	D			
Frequency Range (GHz):	5.85-8.2			7.05-10.0			8.2-12.4			12.4-18.0			18.0-26.5			26.5-40.0					
Nominal Coupling (dB)*:	3	10	20	3	10	20	3	10	20	3	10	20	3	10	20	3	10	20			
Mean Coupling Accuracy (dB):	±0.4			±0.4			±0.4			±0.4			±0.7			±0.7					
Maximum Coupling Variation (dB):	±0.5			±0.5			±0.5			±0.5			±0.5			±0.5 ±0.5 ±0.6					
Minimum Directivity (dB):	40			40			40			40			40			40					
Maximum Primary Line SWR:	1.1	1.05	1.05	1.1	1.05	1.05	1.1	1.05	1.05	1.1	1.05	1.05	1.1	1.05	1.05	1.1	1.05	1.05			
Maximum Auxiliary Arm SWR:	1.15			1.15			1.15			1.2			1.2			1.2					
Primary Line Power Handling Capability:																					
Auxiliary Arm Load Average Power:	1 W			1 W			1 W			1 W			0.5 W			0.5 W					
Maximum Primary Line Residual Loss (dB):																					
Fits Waveguide Size, Nom. O.D. (in): (EIA)	1½x¾ (WR137)			1¼x¾ (WR112)			1x½ (WR90)			.702x.391 (WR62)			.500x.250 (WR42)			.360x.220 (WR28)					
Dimensions (in/mm)†:	26½ 673	25 ⅝ 649	25 ⅝ 649	18 ⅝ 473	17½ 445	17½ 445	16 ⅞ 424	15 ⅞ 399	15 ⅞ 399	13¾ 349	12¼ 311	12¼ 311	10 ⅝ 270	9 ⅞ 252	9 ⅞ 252	11 ⅝ 295	8 ⅝ 219	8 ⅝ 222			
Weight (lbs/kg):	Net Shipping			5¼/2.4 13/5.8			2¾/1.2 4/1.8			1¾/0.8 3/1.4			¾/0.34 2/0.9			½/0.23 1/0.45			¼/0.11 1/0.45		

* Nominal Coupling, Coupling Factor, Coupling Attenuation are terms that describe the same parameter.

† Dimension given is for length only.



SPECIFICATIONS

Model:	DIRECTIONAL DETECTORS					DIRECTIONAL BRIDGES		
	784A	786D	787D	788C	789C	8721A	15520A*	15537A*
Frequency Range (GHz):	2-12.4	0.96-2.11	1.9-4.1	3.7-8.3	8-12.4	0.1-110 MHz	45-95 MHz	0.5-20 MHz
Nominal Coupling (dB) \diamond \diamond :						6	6	3
Low Level Sensitivity (μ V/ μ W):	> 12	> 4	> 4	> 40	> 20			
Maximum Coupling Variation (dB):	$\dagger \pm 1.5$ \diamond	± 0.2 \diamond	± 0.2 \diamond	± 0.3 \diamond	± 0.5 \diamond	< 0.6	± 0.5	± 0.5
Minimum Directivity (dB):	19, 2-4 GHz 16, 4-8 GHz 13, 8-12.4 GHz	30	26	20	17	40, 1-110 MHz 30, 0.1-1 MHz	44**	54**
Maximum Primary Line SWR:	1.4	1.15	1.15	1.20	1.4	1.06	1.02	1.02
Maximum Auxiliary Arm SWR:						1.07	1.02	1.02
Equivalent Source Match:	1.2, 1.7-6.5 GHz 1.5, 6.5-12.4 GHz	1.13	1.16	1.25	1.25			
Primary Line Power Handling Capability:	10 W ave.	10 W ave.	10 W ave.	1 W ave.	1 W ave.	0.1 W ave.	0.1 W ave.	0.1 W ave.
Characteristic Impedance (ohms):	50	50	50	50	50	50 (75 opt.)	75	75
Maximum Primary Line Residual Loss (dB):	1.0	0.25	0.35	0.6	0.7	6	6	3
Primary Line/Auxiliary Arm Connectors:	"N"(f,m)/ BNC (f)	"N"(m,f)/ BNC (f)	"N"(m,f)/ BNC (f)	"N"(m,f)/ BNC(f)	"N"(m,f)/ BNC(f)	BNC/BNC	BNC/BNC	BNC/BNC
Dimensions (inches/mm):	5 $\frac{3}{4}$ /146 \ddagger	6/152 \ddagger	4 $\frac{1}{4}$ /124 \ddagger	4 $\frac{1}{4}$ /124 \ddagger	11 $\frac{1}{8}$ /295 \ddagger	1 $\frac{1}{2}$ x1x3 $\frac{3}{8}$ 38x25x79	2 $\frac{1}{2}$ x2 $\frac{3}{4}$ x $\frac{7}{8}$ 63x69x22	3x3x $\frac{3}{4}$ 75x75x19
Weight (lbs/kg):	Net 1/0,45 Shipping 2/0,9	1/0,45 2/0,9	$\frac{3}{4}$ /0,34 2/0,9	$\frac{3}{4}$ /0,34 2/0,9	1 $\frac{3}{4}$ /0,78 2/0,9	$\frac{1}{4}$ /0,11 $\frac{1}{2}$ /1,1	$\frac{3}{16}$ /0,1	$\frac{3}{16}$ /0,14
Options Available:		002, 003	002, 003	002,003	002,003	008	002,003	

\diamond \diamond Nominal Coupling, Coupling Factor, Coupling Attenuation are terms that describe the same parameter.

\dagger ± 0.01 dB over any 30 MHz band.

\diamond Specification is for Frequency Response, includes coupler and detector variation.

** Specification is for Equivalent Minimum Return Loss.

\ddagger Dimension given is length only.

* 4-Port hybrid.

Options: 786-789, 002 Furnished with load resistor for optimum square law characteristics at 24°C.

786-789, 003 Positive polarity detector output.

008 75 Ω version.

15520A/15537A, 002 Siemens 2.5 mm connectors.

15520A/15537A, 003 Siemens 1.6 mm connectors.



SLOTTED LINE EQUIPMENT
AND SLIDE SCREW TUNERS

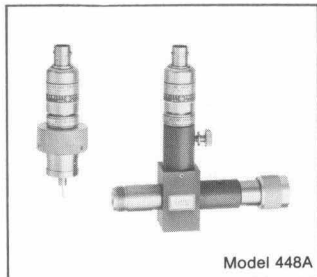

Model 448A

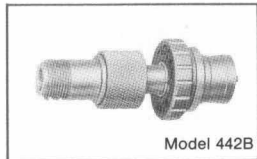

Model 442B



Model 447B

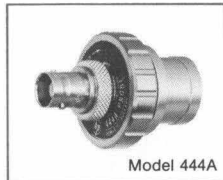

Model 444A



Model 446B

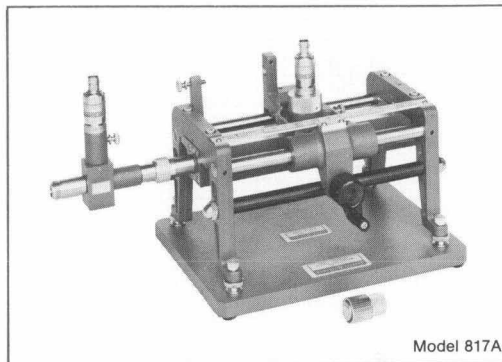

Model 817A

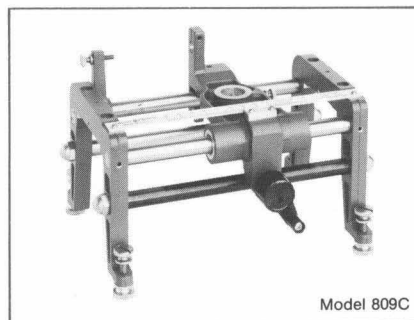

Model 809C

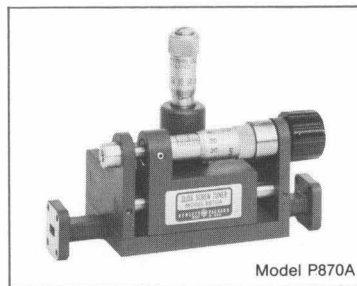

Model P870A

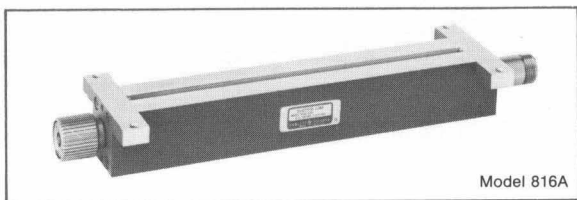

Model 816A

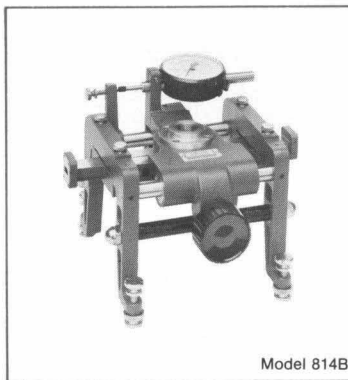

Model 814B

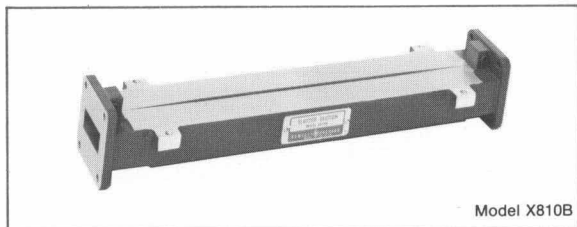

Model X810B

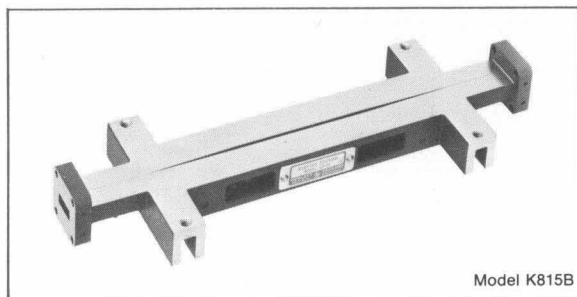

Model K815B

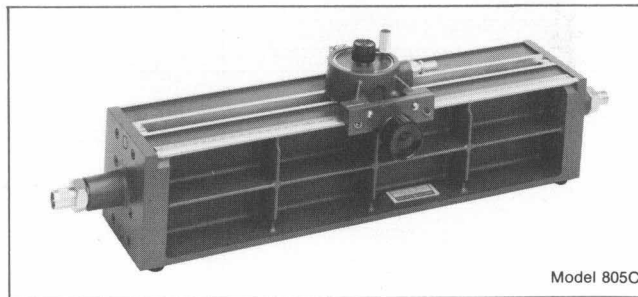

Model 805C



measure:

Standing Wave Magnitude and Phase

Impedance Magnitude and Phase

System Flatness

Wavelength

Percent of Transmitted or Reflected Power

- Quickly
 - Accurately
 - Fixed or Swept Frequency Testing
-

SLOTTED LINE EQUIPMENT AND SLIDE SCREW TUNERS



SPECIFICATIONS

Model:

Frequency Range (GHz):

Characteristic Impedance (ohms):

Maximum Residual SWR:

Maximum Slope and Irregularities:

Connectors:

Waveguide I.D. (in):

Fits Waveguide Size, Nom. O.D. (in):
(EIA)

Equivalent Flange:

Dimensions (in/mm):

Weight (lbs/kg):

Net
Shipping

Carriage:

Accessories Furnished†:

Accessories Available†:

Options Available:

* Maximum VSWR values (20:1) can be corrected with an accuracy of 1.02 and small SWR's may be easily corrected.
Residual loss at corrected SWR of 20 is 2 dB maximum.

† See Accessories Section, page 53

◇ Dimension given is length only.

‡ Included in Residual SWR.

Options: 022 Type N male and Type N female connectors.



SLOTTED LINE	SLOTTED LINE SECTIONS								SLIDE SCREW TUNERS	
	805C	816A	J810B	H810B	X810B	P810B	K815B	R815B	X870A	P870A
5-4.0	1.8-18.0	5.30-8.20	7.05-10.0	8.20-12.4	12.4-18	18-26	26.5-40	8.2-12.4	12.4-18	
50	50 ± 0.2									
1.04	1.04	1.01	1.01	1.01	1.01	1.01	1.01	*	*	
0.2 dB	0.1 dB per ½ wave length	‡	‡	‡	‡	‡	‡			
"N"(m,f)	APC-7, "N"(f)	WG (see below)	WG (see below)	WG (see below)	WG (see below)	WG (see below)	WG (see below)	WG (see below)	WG (see below)	WG (see below)
		1.372 ± .002 x .622 ± .002	1.122 ± .0015 x .497 ± .0015	.900 ± .001 x .400 ± .0015	.622 ± .001 x .311 ± .001	.420 ± .0005 x .170 ± .0005	.280 ± .0005 x .140 ± .0005	.900 ± .001 x .400 ± .0015	.622 ± .001 x .311 ± .001	
		1½x¾ (WR137)	1¼x¾ (WR112)	1x½ (WR90)	.702x.391 (WR62)	500x.250 (WR42)	.360x.220 (WR28)	1x½ (WR90)	.702x.391 (WR62)	
		UG-441/U	UG-138/U	UG-135/U	UG-419/U	UG-595/U	UG-599/U	UG-39/U	UG-419/U	
26½x7x7 673x178x178	9¾/248 ◊	10¼/260 ◊	10¼/260 ◊	10¼/260 ◊	10¼/260 ◊	7¾/192 ◊	7¾/192 ◊	5½/104 ◊	5/127 ◊	
18/ 8,1 27/12,1	1¼/0,6 3/1,4	1¾/0,8 3/1,4	1¾/0,63 2/0,9	1¾/0,55 2/0,9	¾/0,39 2/0,9	1/0,45 2/0,9	1/0,45 2/0,9	1¼/0,56 2/0,9	¾/0,34 2/0,9	
Integral	Fits 809C	Fits 809C	Fits 809C	Fits 809C	Fits 809C	Fits 809C	Fits 814B	Fits 814B		
11512A 11511A	11512A 11565A									
11510A, 11500A, 11501A, 11503A										
	022									



SPECIFICATIONS

	PROBES				SWEEP ADAPTER	CARRIAGES		SLOTTED LINE SYSTEM
Model:	442B	444A	446B	447B	448A	809C	814B	817A
Frequency Range (GHz):	2.6-12.4	2.6-18	18-40	1.8-18	1.8-18			1.8-18
Probe Required:					447B Type	Fits 442B, 444A, 447B, 448A	Fits 446B	448A Included
Probe Travel:						10 cm	.15 cm	10 cm
Accuracy:						reads SWR of 1.02	reads SWR of 1.02	reads SWR of 1.02
Detector:	Not Supplied	modified 1N 76	modified 1N 53	00423-802	2 each 00423-802 Type	See 442B, 444A, 447B, 448A	See 446B	2 each 00423-802 Type
Maximum Power:					2 W ave.			2 W ave.
Connectors:	"N"(f) (output)	BNC (f) (output)	BNC (f) (output)	BNC (f) (output)	"N"(m,f) BNC(f)			APC-7 "N"(f)
Slotted Line Section:	Fits 810B	Fits 810B	Fits 815B	Fits 816A	Fits 816A	Mounts 810B,816A	Mounts 815B	816A Included
Carriage:	Fits 809C	Fits 809C	Fits 814B	Fits 809C	Fits 809C			809C Included
Dimensions (in/mm):	1¼x3½ (32x79)	1¼x2½ (32x52)	2¾x1 (57x25)	3½x1½ (89x29)	4½x4¼x¾ (105x108x22)	8½x6¾x5¼ (226x174x148)	6¼x6¼x6½ (159x159x165)	13½x7x7 (343x178x178)
Weight (lbs/kg):	Net ¾/0,17 Shipping ½/0,23	¾/0,17 ½/0,23	½/0,23 1/0,45	¾/0,17 1/0,45	¾/0,39 2/0,9	4/1,8 5/2,3	4/1,8 8/3,6	14¾/6,6 22/9,9
Accessories Furnished:								11512A ◊ 11565A
Accessories Available:	440A†	11506A**						11524A * 11525A, 11533A,11534A
Options Available:								022

* See Accessories Section, page 53

† See Detector Section, page 31

◊ See Terminations Section, page 49

** Probe extensions Kit.

Options: 022 Type N male and Type N female connectors

**coaxial and
waveguide attenuators
for a wide variety
of functions:**

- Reduction of Power Levels
 - Reduction of Source Mismatch
 - Reduction of Detector Mismatch
 - Measurement of Reflection Coefficient
 - Measurement of Insertion Loss
 - Measurement of Transfer Characteristics
by RF Substitution
-

**ATTENUATORS
FIXED, VARIABLE
AND
PROGRAMMABLE**

by:

Users of Bench Setups
Instrument Manufacturers
Systems Manufacturers

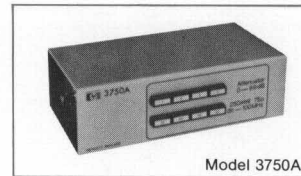

Model 3750A

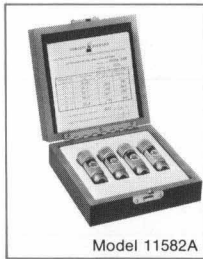

Model 11582A

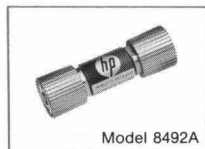

Model 8492A



Model 8493A

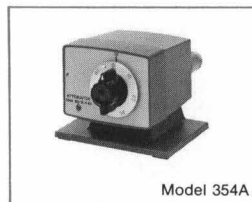

Model 354A

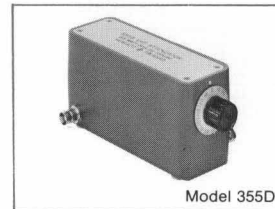

Model 355D

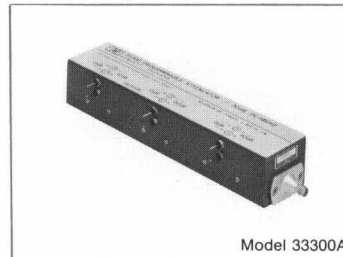

Model 33300A

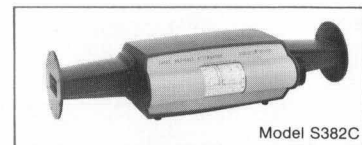

Model S382C

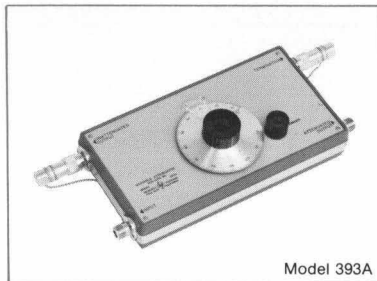

Model 393A

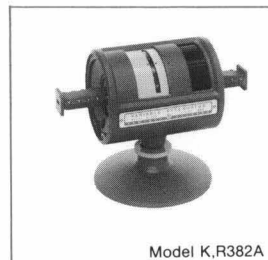

Model K,R382A

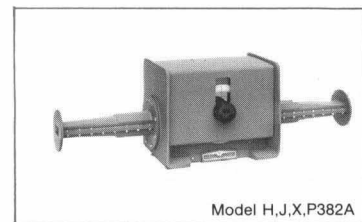

Model H,J,X,P382A

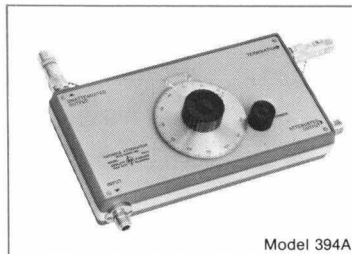

Model 394A

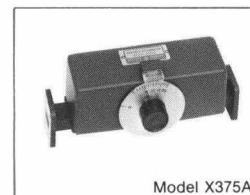

Model X375A



SPECIFICATIONS

Model:

Mode of Operation:

Frequency Range:

Incremental Attenuation (dB):

Attenuation Accuracy:

Maximum Residual Attenuation*(dB):

Maximum SWR:

Power Handling Capability:

Power Sensitivity:

Power Required to Switch One Section:

Solenoid Voltage:

Switching Speed:

Repeatability (typ after 10⁶ cycles):

Minimum Life:

Connectors:

Dimensions (in/mm):

Weight (lbs/kg):

Net
Shipping

Maximum Attenuation Temperature Coefficient (dB/dB/°C):

Options Available:

* Residual Attenuation is also referred to as Insertion Loss.

† Continuous operation of solenoids requires 10 watts dissipation in heat sink for 33300 and 33301; 13 watts dissipation for 33304 and 33305.

◇ Available in four versions: A-12 volts, no indicator contacts; B-24 volts, no indicator contacts;
C-12 volts, with indicator contacts; D-24 volts, with indicator contacts.

** Series is available with any combination of 3mm, 7mm, or Type N connectors. A three digit code specifies these options.
The first digit is always 0. The second digit calls out port 1, the third, port 3. See table 9 for details.



	354A	355C	355D	393A	394A	33300 ◊	33301 ◊	33304 ◊	33305 ◊	3750A‡
	Variable Step	Variable Step	Variable Step	Continuously Variable	Continuously Variable	Programmable Step	Programmable Step	Programmable Step	Programmable Step	Variable Step
	DC-12.4 GHz	DC-1 GHz	DC-1 GHz	5-1 GHz	1-2 GHz	DC-18 GHz	DC-18 GHz	DC-18 GHz	DC-18 GHz	DC-100 MHz
	0-60 in 10 dB steps	0-12 in 1 dB steps	0-120 in 10 dB steps	5-120	6-120	0-70 in 10 dB steps	0-42 in 6 dB steps	0-11 in 1 dB steps	0-110 in 10 dB steps	0-99 in 1 dB steps
	± 2 dB	See Table 1	See Table 1	Greater of ± 1.25 dB or ± 1.75%	Greater of ± 1.25 dB or ± 2.5%	See Table 5	See Table 6	See Table 7	See Table 8	± 2 dB
	1.5	See Table 2	See Table 2			0.5+0.08freq (freq in GHz)	0.5+0.08freq (freq in GHz)	0.7+0.1freq (freq in GHz)	0.7+0.1freq (freq in GHz)	
	1.5, DC-8 1.75, 8-12.4	See Table 3	See Table 3	See Table 4	See Table 4	See Table 13	See Table 13	See Table 13	See Table 13	1.08
	2 W ave. 300 W peak	.5 W ave. 350 W peak	.5 W ave. 350 W peak	200 W ave.	200 W ave.	2 W ave. 500 W peak	2 W ave. 500 W peak	2 W ave. 500 W peak	2 W ave. 500 W peak	.25 W ave.
	.001 dB/dB/watt					.001 dB/dB/watt	.001 dB/dB/watt	.001 dB/dB/watt	.001 dB/dB/watt	
						3.3 W†	3.3 W†	3.3 W†	3.3 W†	
						◊	◊	◊	◊	
						50 msec	50 msec	50 msec	50 msec	
						.02 dB,DC-12.4 .04 dB,12.4-18	.02 dB,DC-12.4 .04 dB,12.4-18	.03 dB,DC-12.4 .05 dB,12.4-18	.03 dB,DC-12.4 .05 dB,12.4-18	
	10,000 cycles	25,000 cycles	25,000 cycles			10 ⁶ steps each section	10 ⁶ steps each section	10 ⁶ steps each section	10 ⁶ steps each section	
	"N"(f)	See Options Note	See Options Note	See Options Note	See Options Note	See Options Note	See Options Note	See Options Note	See Options Note	BNC
	4x3½x4½ (102x79x114)	6x2¾x2% (152x70x67)	6x2¾x2% (152x70x67)	12x5½x2¾ (305x140x70)	12x5½x2¾ (305x140x70)	7x1½x1¼ (178x38x32)	7x1½x1¼ (178x38x32)	9½x1½x1¼ (242x38x32)	9½x1½x1¼ (242x38x32)	8x4x2½ (203x102x64)
	2¼/1,2 4/1,8	1½/0,7 3/1,4	1½/0,7 3/1,4	6/2,7 13/5,8	6/2,7 13/5,8	1¼/0,6 3/1,4	1¼/0,6 3/1,4	1½/0,7 3½/1,7	1½/0,7 3½/1,7	3/1,4
	.0001					.0001	.0001	.0001	.0001	
		001, 003, 005	001, 003, 005	001	001	**	**	**	**	

‡ Characteristic Impedance: 75 Ω
Options: 355C/D; 001 Type N connectors.
355C/D; 003 Panel mounting capability.
355C/D; 005 Type TNC connectors.
393A/394A; 001 supplied without 908A coaxial terminations.



TABLE 1

ATTENUATION ACCURACY		
Frequency	355C	355D
1000 Hz	± 0.1 dB	± 0.3 dB to 120 dB
DC-500 MHz	± 0.25 dB	—
DC-1 GHz	± 0.35 dB	± 1.5 dB to 90 dB; ± 3 dB to 120 dB

TABLE 2

RESIDUAL ATTENUATION		
Frequency	355C	355D
100 MHz	0.25 dB	0.25 dB
100-500 MHz	0.75 dB	0.75 dB
500 MHz-1 GHz	1.5 dB	1.5 dB

TABLE 3

SWR (input and output)		
Frequency	355C	355D
DC-250 MHz	1.2	1.2
250-500 MHz	1.3	1.3
500 MHz- 1 GHz	1.5	1.5

TABLE 4

SWR (input and output)		
Attenuation Range	393A	394A
5-15 dB	2.5	2.5
15-30 dB	1.5	1.8
30-120 dB	1.2, input 1.4, output	1.6

TABLE 5

ATTENUATION ACCURACY							
Frequency Range	Attenuator Setting (dB)						
	10	20	30	40	50	60	70
DC-12.4 GHz	± 0.5	± 0.7	± 0.9	± 1.2	± 1.5	± 1.8	± 2.1
DC-18 GHz	± 0.6	± 0.8	± 1.2	± 1.6	± 2.0	± 2.4	± 2.8

TABLE 6

ATTENUATION ACCURACY							
Frequency Range	Attenuator Setting (dB)						
	6	12	18	24	30	36	42
DC-12.4 GHz	± 0.4	± 0.5	± 0.7	± 0.8	± 0.9	± 1.1	± 1.2
12.4-18 GHz	± 0.5	± 0.6	± 0.8	± 1.0	± 1.2	± 1.6	± 2.0

TABLE 7

ATTENUATION ACCURACY											
Frequency Range	Attenuator Setting (dB)										
	1	2	3	4	5	6	7	8	9	10	11
DC-4 GHz	± 0.2	± 0.2	± 0.3	± 0.3	± 0.3	± 0.3	± 0.4	± 0.4	± 0.4	± 0.4	± 0.5
4-12.4 GHz	± 0.3	± 0.3	± 0.4	± 0.4	± 0.4	± 0.4	± 0.5	± 0.5	± 0.5	± 0.5	± 0.6
12.4-18 GHz	± 0.4	± 0.4	± 0.5	± 0.5	± 0.6	± 0.6	± 0.7	± 0.7	± 0.8	± 0.8	± 0.9

TABLE 8

ATTENUATION ACCURACY											
Frequency Range	Attenuator Setting (dB)										
	10	20	30	40	50	60	70	80	90	100	110
DC-12.4 GHz	± 0.5	± 0.7	± 0.9	± 1.2	± 1.5	± 1.8	± 2.1	± 2.4	± 2.7	± 3.0	± 3.3
12.4-18 GHz	± 0.6	± 0.8	± 1.2	± 1.6	± 2.0	± 2.4	± 2.8	± 3.2	± 3.6	± 4.0	± 4.4

TABLE 9

Option Code	Connector Type
0	Type N Jack
1	Type N Plug
2	7mm Jack
3	7mm Plug
5	SMA Jack
6	SMA Plug



SPECIFICATIONS

COAXIAL ATTENUATORS

Model:	8491A	8491B	8492A	8493A	8493B	11581A*	11582A†	11583A◇
Mode of Operation:	Fixed	Fixed	Fixed	Fixed	Fixed	Fixed	Fixed	Fixed
Frequency Range (GHz):	DC-12.4	DC-18	DC-18	DC-12.4	DC-18	DC-12.4	DC-18	DC-18
Attenuation Accuracy (dB):								
3 dB	±0.3	±0.3	±0.3	±0.3	±0.3	±0.3	±0.3	±0.3
6 dB	±0.3	±.3, DC-12.4 ±.4, 12.4-18	±.3, DC-12.4 ±.4, 12.4-18	±0.3	±.3, DC-12.4 ±.4, 12.4-18	±0.3	±.3, DC-12.4 ±.4, 12.4-18	±.3, DC-12.4 ±.4, 12.4-18
10 dB	±0.5	±0.5	±0.5	±0.5	±0.5	±0.5	±0.5	±0.5
20 dB	±0.5	±.5, DC-12.4 ±1, 12.4-18	±.5, DC-12.4 ±1, 12.4-18	±0.5	±.5, DC-12.4 ±1, 12.4-18	±0.5	±.5, DC-12.4 ±1, 12.4-18	±.5, DC-12.4 ±1, 12.4-18
30 dB	±1	±1	±1	±1	±1			
40 dB	±1.5	±1.5	±1.5					
50 dB	±1.5	±1.5	±1.5					
60 dB	±2	±2	±2					
Maximum SWR:	See Table 10	See Table 11	See Table 12	See Table 10	See Table 11	See Table 10	See Table 11	See Table 12
Calibration Frequencies:	DC, 4, 8, 12 GHz	DC, 4, 8, 12, 18 GHz	DC, 4, 8, 12, 18 GHz	DC, 4, 8, 12 GHz	DC, 4, 8, 12, 18 GHz	DC, 4, 8, 12 GHz	DC, 4, 8, 12, 18 GHz	DC, 4, 8, 12, 18 GHz
Maximum Input Power:	2 W ave. 100 W peak	2 W ave. 100 W peak	2 W ave. 100 W peak	2 W ave. 100 W peak	2 W ave. 100 W peak	2 W ave. 100 W peak	2 W ave. 100 W peak	2 W ave. 100 W peak
Connectors:	Type N	Type N	APC-7	SMA	SMA	Type N	Type N	APC-7
Dimensions (in/mm):	2 ⁷ / ₁₆ x 1 ³ / ₁₆ (62x21)	2 ⁷ / ₁₆ x 1 ³ / ₁₆ (62x21)	2 ³ / ₄ x 1 ³ / ₁₆ (70x21)	1 ¹ / ₁₆ x 1/2 (40x13)	1 ¹ / ₁₆ x 1/2 (40x13)	See 8491A	See 8491B	See 8492A
Weight (lbs/kg):	Net 1/4/0,11	1/4/0,11	1/4/0,11	1/16/0,03	1/16/0,03	2/0,88	2/0,88	2/0,88
	Shipping 1/2/0,22	1/2/0,22	1/2/0,22	1/2/0,22	1/2/0,22	4/1,76	4/1,76	4/1,76
Options Available:	**	**	**	**	**			

* Set of four 8491A, includes 3, 6, 10, 20 dB values.

† Set of four 8491B, includes 3, 6, 10, 20 dB values.

◇ Set of four 8492A, includes 3, 6, 10, 20 dB values.

In addition to the calibration stamping on the bodies of the attenuators, each set includes a calibration report.

** Option numbers same as attenuation values; e.g., Option '003 for 3 dB, Option 006 for 6 dB, Option 010 for 10 dB, etc.



Table 10
SWR

Attenuation	DC-8 GHz	8-12.4 GHz
3 dB	1.25	1.35
6 dB	1.2	1.3
10 dB	1.2	1.3
20 dB	1.2	1.3
30 dB	1.2	1.3
40 dB	1.2	1.3
50 dB	1.2	1.3
60 dB	1.2	1.3

Table 11
SWR

Attenuation	DC-8 GHz	8-12.4 GHz	12.4-18 GHz
3 dB	1.25	1.35	1.5
6 dB	1.2	1.3	1.5
10 dB	1.2	1.3	1.5
20 dB	1.2	1.3	1.5
30 dB	1.2	1.3	1.5
40 dB	1.2	1.3	1.5
50 dB	1.2	1.3	1.5
60 dB	1.2	1.3	1.5

Table 12
SWR

Attenuation	DC-8 GHz	8-12.4 GHz	12.4-18 GHz
3 dB	1.2	1.3	1.5
6 dB	1.2	1.3	1.35
10 dB	1.15	1.25	1.3
20 dB	1.15	1.25	1.3
30 dB	1.15	1.25	1.3
40 dB	1.15	1.25	1.35
50 dB	1.15	1.25	1.35
60 dB	1.15	1.25	1.35

Table 13
SWR

Frequency	33300			33301			33304			33305		
	SMA	Type N	7mm	SMA	Type N	7mm	SMA	Type N	7mm	SMA	Type N	7mm
DC-8 GHz	1.35	1.3	1.25	1.35	1.3	1.25	1.5	1.45	1.4	1.5	1.45	1.4
8-12.4 GHz	1.5	1.4	1.35	1.5	1.4	1.35	1.6	1.55	1.5	1.6	1.55	1.5
12.4-18 GHz	1.7	1.6	1.5	1.7	1.6	1.5	1.9	1.8	1.7	1.9	1.8	1.7



SPECIFICATIONS

WAVEGUIDE ATTENUATORS

Model:	X375A	P375A	S382C	J382A	H382A	X382A	P382A	K382A	R382A
Mode of Operation:	Continuously Variable	Continuously Variable	Continuously Variable	Continuously Variable	Continuously Variable	Continuously Variable	Continuously Variable	Continuously Variable	Continuously Variable
Frequency Range (GHz):	8.2-12.4	12.4-18.0	2.6-3.95	5.3-8.2	7.05-10.0	8.2-12.4	12.4-18.0	18.0-26.5	26.5-40.0
Incremental Attenuation (dB):	0-20	0-20	0-60	0-50	0-50	0-50	0-50	0-50	0-50
Attenuation Accuracy:	◊	◊	†	greater of 0.1 dB or 2%	greater of 0.1 dB or 2%	greater of 0.1 dB or 2%	greater of 0.1 dB or 2%	greater of 0.1 dB or 2%	greater of 0.1 dB or 2%
Maximum Residual Attenuation (dB)*:	0.5	0.5	1	1	1	1	1	1	1
Maximum SWR:	1.15	1.15	1.2	1.15	1.15	1.15	1.15	1.15	1.15
Maximum Reflection Coefficient:	0.07	0.07	0.091	0.07	0.07	0.07	0.07	0.07	0.07
Power Handling Capability:	2 W ave.	1 W ave.	10 W ave.	10 W ave.	10 W ave.	10 W ave.	5 W ave.	2 W ave.	1 W ave.
Fits Waveguide Size, Nom. O D (in) (EIA)	1x½ (WR90)	.702x.391 (WR62)	3x1½ (WR284)	1½x¾ (WR137)	1½x¾ (WR112)	1x½ (WR90)	.702x.391 (WR62)	½x¼ (WR42)	.360x.220 (WR28)
Equivalent Flange:	UG-39/U	UG-419/U	UG-584/U	UG-441/U	UG-138/U	UG-135/U	Cover (Al)	UG-597/U	Cover (Al)
Dimensions (in/mm):	± 7½/183	± 7¼/184	25¼x6x8 (641x152x203)	25x7¾x6¾ (635x200x157)	20x7½x6½ (508x202x165)	15½x7¾x4¼ (397x194x119)	12½x7¾x4¾ (318x197x121)	7¾x6½x4¾ (194x156x121)	6¾x6½x4¾ (162x156x121)
Weight (lbs/kg):	Net 2/0,9 Shipping 3/1,4	1¾/0,79 3/1,4	18/ 8,1 28/12,6	13/ 5,9 24/10,9	10/4,5 22/9,9	6/2,7 8/3,6	6/2,7 8/3,6	4/1,8 9/4,1	4/1,8 9/4,1
Accessories Available**:								11515A	11516A

* Residual Attenuation is also referred to as Insertion Loss.

† ± 1% of reading in dB or 0.1 dB, whichever is greater, from 0 to 50 dB; ± 2% of reading above 50 dB.

◊ ± 1 dB, zero to 10 dB; 2 dB, 10 to 20 dB.

** See Accessories section, page 53

‡ Dimension given is length only.

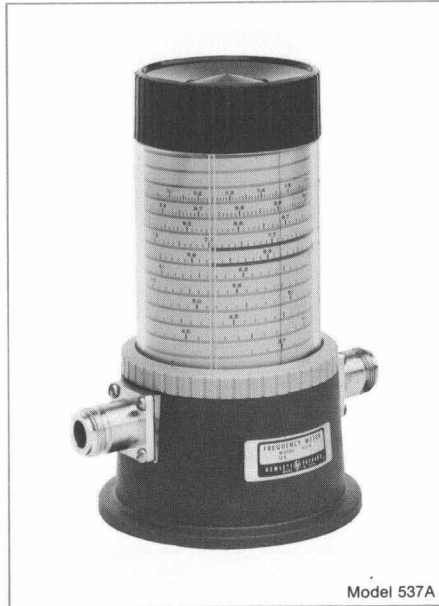

Model 537A

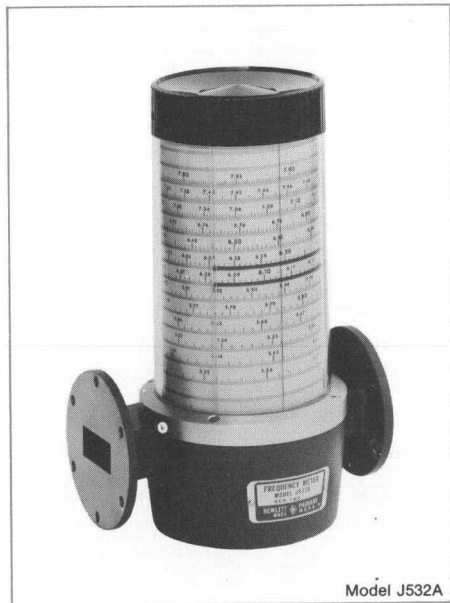

Model J532A

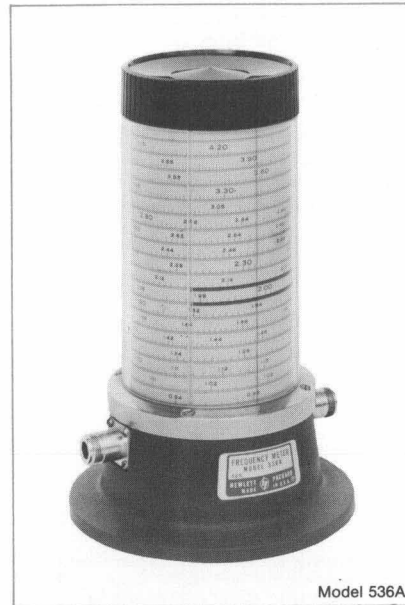

Model 536A



advantages:

- HIGH RESOLUTION, EASY-TO-READ DIAL
 - DIRECT READING
 - BROADBAND
 - ACCURACY SPECIFIED OVER 20°C AND 0 TO 100% RELATIVE HUMIDITY
-

**FREQUENCY
METERS**



SPECIFICATIONS

Model:	536A	537A	J532A	H532A	X532B	P532A	K532A	R532A
Frequency Range (GHz):	0.96-4.2	3.7-12.4	5.3-8.2	7.05-10	8.2-12.4	12.4-18	18-26.5	26.5-40
Dial Accuracy (%):	.1, 1-4.2 GHz .15, .96-1 GHz	0.10	0.033	0.040	0.050	0.068	0.077	0.083
Overall Accuracy (%):	.17, 1-4.2 GHz .22, .96-1 GHz	0.17	0.065	0.075	0.08	0.10	0.11	0.12
Minimum Dip at Resonance (dB):	1, 1-4 GHz .6, .96-1 GHz .6, 4-4.2 GHz	1	1	1	1	1	1	1
Maximum Reflection Coefficient Off Resonance:	0.091	0.33						
Calibration Increments (MHz):	2	10	2	2	5	5	10	10
Minimum Calibration Spacing (in):	$\frac{1}{16}$	$\frac{1}{32}$	$\frac{1}{32}$	$\frac{1}{32}$	$\frac{1}{32}$	$\frac{1}{32}$	$\frac{1}{32}$	$\frac{1}{32}$
Maximum Temperature Coefficient (%/°C):	0.0016	0.0016	0.0012	0.0015	0.0010	0.0012	0.0013	0.0017
Connectors:	"N"(f)	"N"(f)	WG (See below)	WG (See below)	WG (See below)	WG (See below)	WG (See below)	WG (See below)
Fits Waveguide Size, Nom. O.D. (in): (EIA)			$1\frac{1}{2} \times \frac{3}{4}$ (WR137)	$1\frac{1}{4} \times \frac{5}{8}$ (WR112)	$1 \times \frac{1}{2}$ (WR90)	0.702x0.391 (WR62)	$\frac{1}{2} \times \frac{1}{4}$ (WR42)	0.360x0.220 (WR28)
Equivalent Flange:			UG-441/U	UG-138/U	UG-39/U	UG-419/U	UG-595/U	UG-599/U
Dimensions (in/mm):	$6 \times 9\frac{1}{8} \times 6$ (152x232x152)	$4\frac{5}{8} \times 5\frac{3}{4} \times 3\frac{1}{2}$ (118x146x89)	$6\frac{1}{4} \times 9\frac{1}{8} \times 4\frac{1}{2}$ (159x232x114)	$6\frac{1}{4} \times 8 \times 4\frac{3}{8}$ (159x203x111)	$4\frac{1}{2} \times 6\frac{1}{8} \times 2\frac{7}{8}$ (114x156x73)	$4\frac{1}{2} \times 6\frac{1}{4} \times 2\frac{3}{8}$ (114x159x70)	$4\frac{1}{2} \times 5\frac{3}{8} \times 2\frac{7}{8}$ (114x137x73)	$4\frac{1}{2} \times 5\frac{1}{2} \times 2\frac{3}{8}$ (114x140x70)
Weight (lbs/kg):	Net Shipping	10/4.5 13/5.9	$3\frac{1}{2}$ /1.6 5/2.3	$7\frac{1}{2}$ /3.4 11/5.0	6/2.7 9/4.1	$3\frac{1}{2}$ /1.6 5/2.3	3/1.4 5/2.3	$1\frac{1}{2}$ /0.7 4/1.8
Accessories Available†:							11515A	11516A

† See Accessories Section, page 53

features:

FLAT FREQUENCY RESPONSE
LOW SWR
HIGH SENSITIVITY
EXCELLENT SQUARE LAW CHARACTERISTICS
WIDE FREQUENCY COVERAGE
ECONOMICAL

CRYSTAL DETECTORS

applications:

RF Detection
Power Leveling
Power Monitoring
Reflection Coefficient Measurements
Attenuation Measurements
Peak Power Measurements

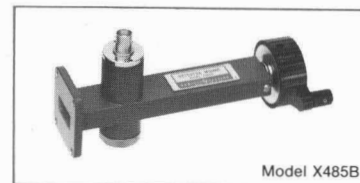
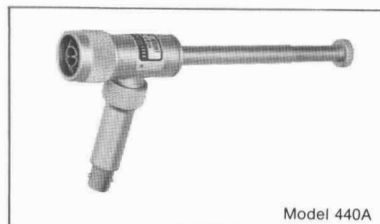
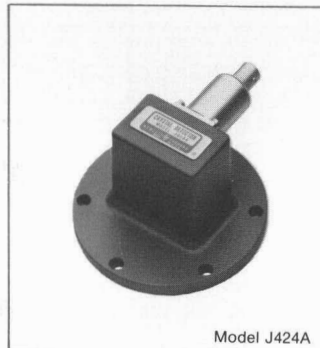
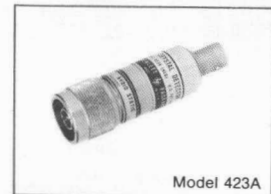
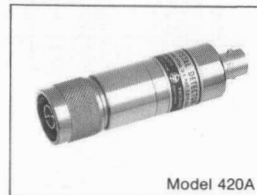
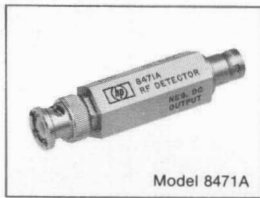

SPECIFICATIONS

Model:	8471A	423A	420A	420B	8470A	8472A	MOUNTS	
							440A**	X485B**
Frequency Range (GHz):	100KHz-1.2 GHz	.01-12.4	.01-12.4	1-4†	.01-18 ◊	.01-18 ◊	2.4-12.4	8.2-12.4
Frequency Response (dB)*:	± .6 typ. ± .1 over 100 MHz	± .2/octave to 8 GHz ± .5 overall	3.5	± 3	± .2/octave to 8 GHz; ± .5 to 12.4 GHz ± 1 overall	same as 8470A		
Minimum Low Level Sensitivity (mV/μW):	0.35	0.4	0.1	0.05	0.4	0.4		
High Level Sensitivity (mW):	> 75% @ input levels > 10mW	< 0.35			< 0.35	< 0.35		
Maximum SWR:	1.3 typ.	1.2 to 4.5 GHz 1.35 to 7 GHz 1.5 to 12.4 GHz	3.0	3.0	1.2 to 4.5 GHz 1.35 to 7 GHz 1.5 to 12.4 GHz 1.7 to 18 GHz	Same as 8470A		1.25
Maximum Input Power (mW, peak or ave.):	3 V rms (4.2 V pk)	100	100	100	100	100		
Input Connector:	BNC (m)	"N" (m)	"N" (m)	"N" (m)	APC-7	SMA (m)	"N" (m)	
Output Connector:	BNC (f)	BNC (f)	BNC (f)	BNC (f)	BNC (f)	BNC (f)	BNC (f)	
Fits Waveguide Size, Nom. O. D. (in): (EIA)								1½x¾ (WR137)
Dimensions (in/mm):	2¾x¾ (70x19)	2½x 2½ ₃₂ (63x20)	3x¾ (76x19)	3x¾ (76x19)	2½x¾ (64x19)	2½x ¾ ₁₆ (64x14)	1¾x2¾ ₁₆ x4½ (21x72x114)	6¾/164‡
Weight (lbs/Kg):	Net ¾/0.07 Shipping 1/0.45	¼/0.11 1/0.45	¼/0.11 1/0.45	¼/0.11 1/0.45	¼/0.11 1/0.45	¼/0.042 ½/0.22	¾/0.14 1/0.45	1/0.45 2/0.9
Options Available:	004, 005, 006	001, 002, 003		001	001, 002, 003 012, 013			

* As read on a 416 Ratio Meter or 415 SWR Meter calibrated for square law detectors. See HP Catalog for details on these instruments.

† The 420B contains a selected crystal and video load; both are installed to achieve best response from 1 to 4 GHz, but unit is usable from 10 MHz-12.4 GHz.

◊ Below 1 GHz, RF may leak through output connector; leakage may be eliminated by using a low pass filter.

** Detectors are not supplied; may use 1N21 or 1N23 crystal for maximum detection sensitivity where SWR is not critical.

‡ Dimension given is length-only.

Options: 423A/8470A: 001 Matched pair frequency response characteristics track within ± 0.2 dB per octave 10 MHz-8 GHz, ± 0.3 dB 8-12.4 GHz, ± 0.6 dB 12.4-18 GHz.
423A/8470A: 002 Less than ± 0.5 dB variation from square law up to 50 mV peak output into > 75KΩ; sensitivity typically > 0.1 mV/μW.

423A/8470A: 003 Positive polarity output.

8470A: 012 Stainless steel Type N male input connector.

8470A: 013 Stainless steel Type N female input connector.

420B: 001 Matched pair. Frequency response characteristics track within ± 1 dB for power levels < approximately 0.1mW.

8471A: 004 Positive polarity output.

8471A: 005 Negative polarity output; 75 Ω input impedance.

8471A: 006 Positive polarity output; 75 Ω input impedance.

SPECIFICATIONS

Model:	S424A	G424A	J424A	H424A	X424A	M424A	P424A	K422A	R422A
Frequency Range (GHz):	2.6-3.95	3.95-5.85	5.3-8.2	7.05-10.0	8.2-12.4	10.0-15.0	12.4-18.0	18.0-26.5	26.5-40.0
Frequency Response (dB)*:	± 0.2	± 0.2	± 0.2	± 0.2	± 0.3	± 0.5	± 0.5	± 2	± 2
Minimum Low Level Sensitivity (mV/μW):	0.4	0.4	0.4	0.4	0.4	0.3	0.3	0.3 typ.	0.3 typ.
Maximum High Level Sensitivity (mW):	0.35	0.35	0.35	0.35	0.35	0.5	0.5		
Maximum SWR:	1.35	1.35	1.35	1.35	1.35	1.5	1.5	2.5	3
Maximum Input Power (mW, ave. or peak):	100	100	100	100	100	100	100	100	100
Fits Waveguide Size, Nom. OD (in): (EIA)	3x1½ (WR284)	2x1 (WR187)	1½x¾ (WR137)	1¼x¾ (WR112)	1x½ (WR90)	.850x.475 (WR75)	.702x.391 (WR62)	.500x.250 (WR42)	.360x.220 (WR28)
Equivalent Flange:	UG-584/U	UG-407/U	UG-441/U	UG-138/U	UG-135/U	Cover (A1)	Cover (A1)	UG-595/U	UG-599/U
Length (in/mm):	2⅞/62	2⅞/52	1⅞/48	1⅞/40	1⅞/35	1/25	1⅞/24	2/51	2/51
Shipping Weight (lbs/kg):	2/0,9	1/0,45	½/0,22	½/0,22	½/0,22	½/0,22	½/0,22	1/0,45	1/0,45
Accessories Available†:								11515A	11516A
Options Available:	001, 002, 003	001, 002, 003	001, 002, 003	001, 002, 003	001, 002, 003	001, 002, 003	001, 002, 003	001, 002	001, 002

* As read on a 416 Ratio Meter or a 415 SWR Meter calibrated for square law detectors. Refer to HP general Catalog for details on these instruments.

† See Accessories Section, page 53

Options: 424A; 001 Matched pair. Frequency response characteristics track within ± 2 dB for S, G, J, and H units, ± 3 dB for X units, ± 5 dB for M and P units.

424A; 002 Less than ± 0.5 dB variation from square law up to 50 mV peak output into > 75 KΩ; sensitivity typically > 0.1 mV/μW.

424A; 003 Positive polarity output.

422A; 001 Matched pair. Frequency response characteristics track within ± 1 dB for power levels < approximately 0.05 mW.

422A; 002 Less than ± 0.5 dB variation from square law up to 50 mV peak output into > 75 KΩ; sensitivity typically > 0.1 mV/μW.

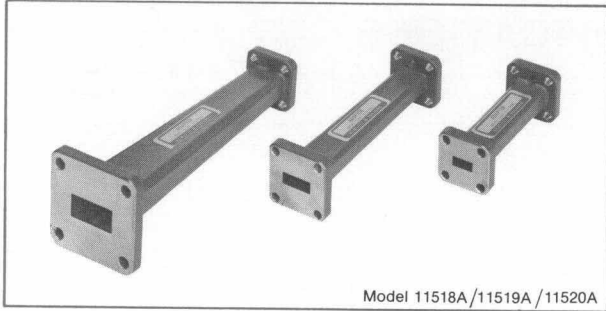

Model 11518A/11519A/11520A

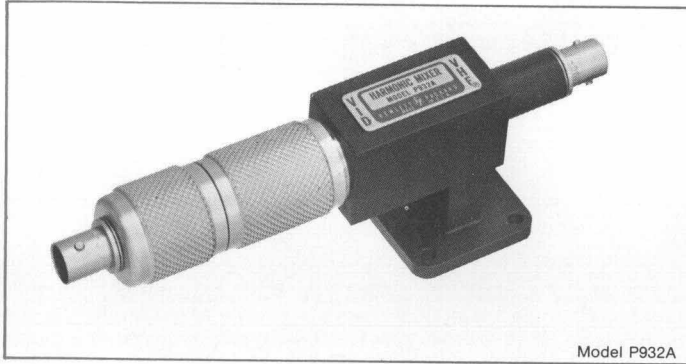

Model P932A



Model 11521A

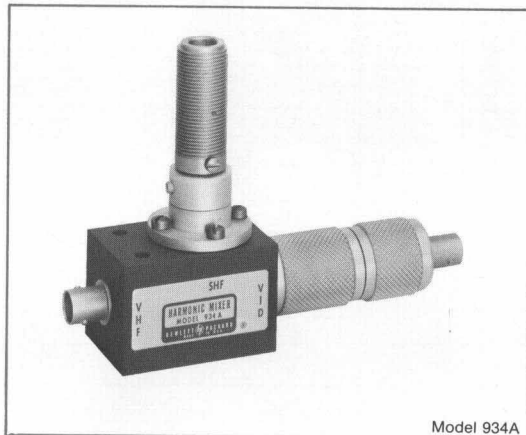

Model 934A

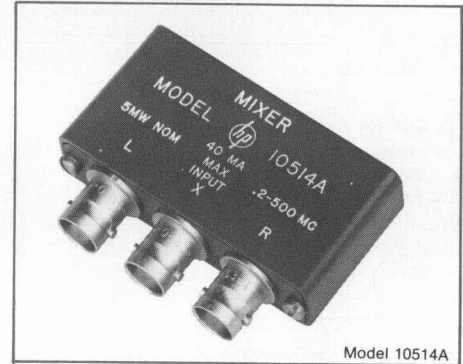

Model 10514A

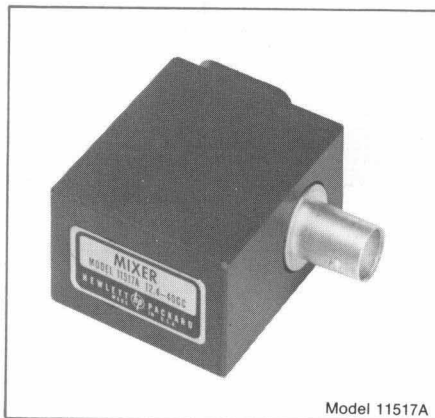

Model 11517A

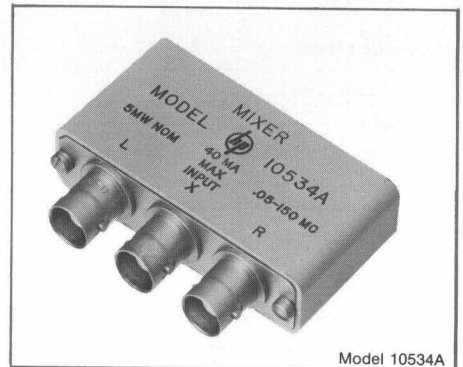

Model 10534A

used for:

Harmonic Mixing
Balanced Mixing
Balanced Modulating
Amplitude Modulating
Pulse Modulating
Phase Detecting

MIXERS



SPECIFICATIONS

	10514A		10534A	
Input Frequency Range:	200 KHz-500 MHz		50 KHz-150 MHz	
Output Frequency Range:	DC-500 MHz		DC-150 MHz	
Maximum Input Power:	80 mW		80 mW	
Maximum Mixer Conversion Loss (dB)†:	7	9	6.5	8
f_L and f_R (MHz)	0.5-50	0.2-500	0.2-35	0.05-150
f_X (MHz)	DC-50	DC-500	DC-35	DC-150
Maximum Noise Performance (dB)†:	6.5	9	6	8
f_L and f_R	0.5-60	60-500	0.2-50	50-165
f_X	0.05-60	0.05-500	0.05-50	0.05-165
Typical Conversion Compression (dB)†:	*		*	
Typical Pulse Modulator Performance:				
Rise or Fall Time	1 ns		1 ns	
Pulse Width	No restriction		No restriction	
On-off Ratio (dB):	35		35	
Saturation Pulse Amplitude:	10 mA; f = 5 mW		10 mA; f = 5 mW	
Modulation Source:	◇		◇	
Linearity:	linear over 30 dB range		linear over 30 dB range	
Connectors:	BNC female		BNC female	
Dimensions (in/mm):	2 1/16 x 1 3/8 x 3/8 (52x42x15)		2 1/16 x 1 3/8 x 3/8 (52x42x15)	
Weight (lbs/kg):	3/8/0,06		3/8/0,06	
Options Available:	001, 002, 003, 004		001, 002, 003, 004	

* By f_L alone: 0.3 dB for 1 mW level. By f_{R2} signal interfering with f_{R1} : 1 dB for f_{R2} level of 1 mW; 10 dB for f_{R2} level of 10 mW (f_L level at 5 mW).

◇ Either + or - polarity turns switch on. Amplitude between pulses, within 2 mV of 0 V.

† See Notes/Terminology for additional information.

Options: 001 TNC jack connectors.
002 SMA jack connectors.
003 Sealectro screw-on connectors.
004 Sealectro snap-on connectors.

MIXER BALANCE (dB) †

Mixer Balance for	Referenced to	10514A		10534A	
		Frequency Ranges f_L, f_R : 0.5-50 f_X : DC-50	Frequency Ranges f_L, f_R : 0.2-500 f_X : DC-500	Frequency Ranges f_L, f_R : 0.5-35 f_X : DC-35	Frequency Ranges f_L, f_R : 0.35-150 f_X : DC-150
f_L at R	f_L	40	30	35	25
f_L at X	f_L	40	20	35	25
f_R at L	f_R	45	30	35	25
f_R at X	f_R	25	15	20	15
f_X at L	f_X	35	15	35	25
f_X at R	f_X	25	15	20	12

NOTES/TERMINOLOGY:

Impedance: The performance of the 10514 and 10534 is specified for 50 Ω source and load impedances. The mixers also work well at other impedance levels, including both 75 Ω and 93 Ω .

Conversion Loss: Conversion loss is the power ratio between the available input power at the "R" port and the power delivered in one of the output sidebands ("L" input = +7 dBm). Conversion loss is not strongly dependent on the available power at the "L" port when this is above 0 dBm.

Noise Performance: For difference frequencies above 50 KHz, noise performance is specified in terms of the relative signal-to-noise ratios at the "R" and "X" ports (i.e., noise figure). The low frequency (1/f) noise contributed by the mixer is specified by the rms noise voltage at the "X" port in a 1 Hz bandwidth centered at 10 Hz.

INTERNAL INTERFERENCE (dB) †

Product	10514A	10534A	Product	10514A	10534A
$2f_L - f_R$	30	40	$2f_R - f_L$	65	65
$3f_L - 2f_R$	70	65	$3f_R - 2f_L$	65	65
$4f_L - 3f_R$	70	65	$4f_R - 3f_L$	85	90
$5f_L - 4f_R$	90	85	$5f_R - 4f_L$	90	90
$6f_L - 5f_R$	95	90	$6f_R - 5f_L$	100	95
$7f_L - 6f_R$	100	95	$7f_R - 6f_L$	100	95

Conversion Compression: Conversion compression describes the increase in conversion loss that occurs as the input to the "R" port is increased in level. "Compression by f_R alone" implies that f_R is a single frequency input. "Compression by f_{R2} interfering with f_{R1} " describes the decrease in $f_L = f_{R1}$ as f_{R2} is increased in level.

Internal Interference: Ideally a mixer produces only sum and difference frequencies of the local oscillator and receive frequencies. Internal interference refers to the higher order mixing products generated when single frequency inputs are impressed on "R" and "L" ports.

Balance: A double balanced mixer suppresses the "R" port signal appearing at both "L" and "X" ports. Similarly the "L" port signal is suppressed at both "R" and "X" ports. In addition, when used as a modulator, the "X" port signal is suppressed at both "L" and "R" ports. The balance specification describes how effective this suppression actually is.

SPECIFICATIONS

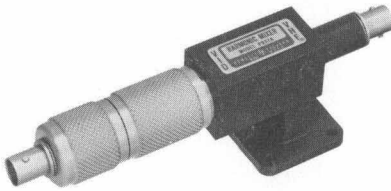

Model P932A

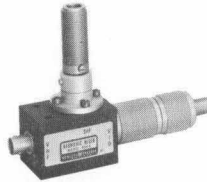

Model 934A

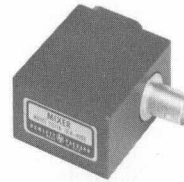

Model 11517A



Model 11521A

	Model:	P932A	934A	11517A	11521A
Input Frequency Range (GHz):		12.4-18	2-12.4	12.4-40	8.2-12.4
Maximum Input Power:		100 mW	100 mW	1 mW	10 mW
Typical Sensitivity (dBm):		-10	-48 at 3.5 GHz -25 at 10 GHz	†	-80
Minimum Video Output*:		0.4 mV peak-peak	1.4 mV peak-peak		
Output Impedance:		1000 Ω shunted by 35 pF	1000 Ω shunted by 35 pF	50 Ω	50 Ω
Connectors:		0.702 x 0.391 (WR62)	"N" (f) BNC (f)	WG input, BNC (f)	WR90 W.G. BNC (f)
Dimensions (in/mm):			5¼x3½x1¼ (133x89x32)	1¾x1¼x¾ (50x46x22)	1¾x2¼x1¾ (41x72x35)
Weight	Net Shipping	1/0,5 2/1	1/0,5 2/1	¾/0,25	3½/100 gr.

*With 0 dBm signal input.

† 12.4-18 GHz: -80 dBm; 18-26.5 GHz: -75 dBm; 26.5-40 GHz: -65 dBm.

ADAPTERS FOR 11517A MIXER

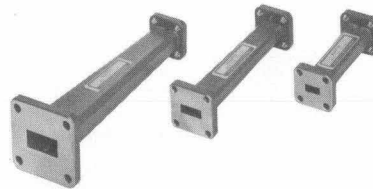

	Model:	11518A	11519A	11520A
Frequency Range (GHz):		12.4-18	18-26.5	26.5-40
Fits Waveguide Size, Nom. O.D. (in): (EIA)		0.702 x 0.391 (WR62)	0.500 x 0.250 (WR42)	0.360 x 0.220 (WR28)
Length (in/mm):		4/102	3/76	2½/52
Weight (lbs/kg):		¾/0,13	¾/0,06	¾/0,06

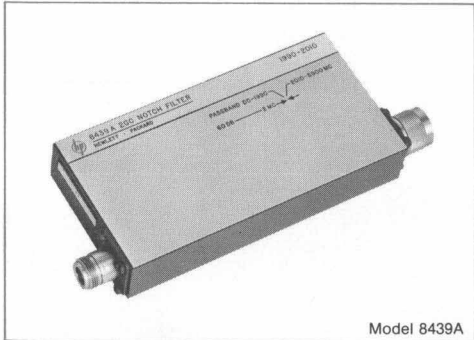

Model 8439A

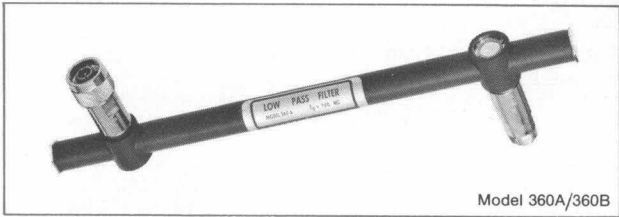

Model 360A/360B

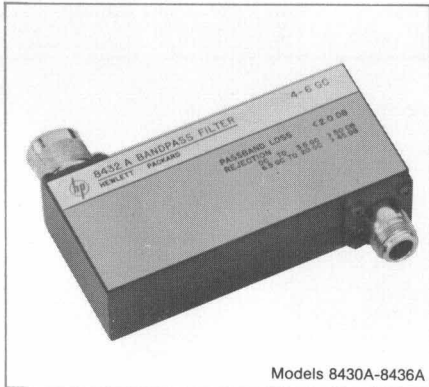

Models 8430A-8436A

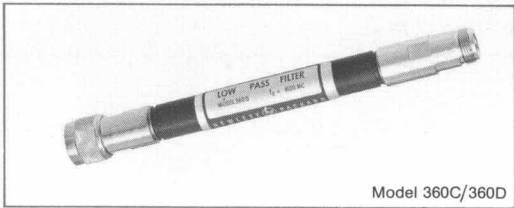

Model 360C/360D

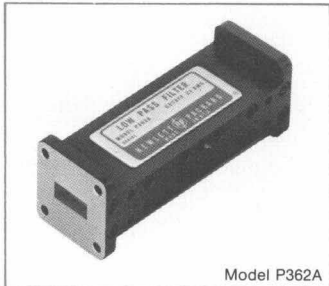

Model P362A

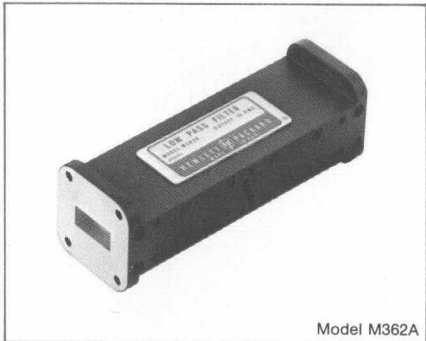

Model M362A

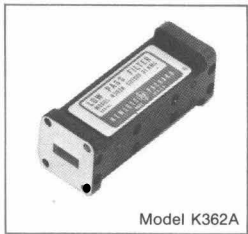

Model K362A



Model R362A



features:

LOW INSERTION LOSS THROUGH PASSBAND
GREATER THAN 50 dB ATTENUATION BEYOND
CUT-OFF FREQUENCY
NO SPURIOUS RESPONSES

uses:

Spectrum Analyzer Preselection
Slotted Line Measurements
Response Determination
Checking Filter Characteristics

**FILTERS
LOW PASS,
BANDPASS
AND NOTCH**



SPECIFICATIONS

LOW PASS FILTERS

Model:	360A	360B	360C	360D	X362A	M362A	P362A	K362A*	R362A*
Cutoff Frequency (GHz):	.700	1.2	2.2	4.1					
Passband Frequency (GHz):					8.2-12.4	10.0-15.5	12.4-18.0	18.0-26.5	26.5-40.0
Stopband Frequency (GHz):					16-37.5	19-47	23-54	31-80	47-120
Maximum Passband Attenuation (dB):	1†	1†	1†	1†	1	1	1	1	2
Above Passband Minimum Rejection (dB):	50 ◊	50 ◊	50 ◊	50 ◊					
Stopband Minimum Rejection (dB):					40	40	40	40	35
Maximum SWR:	1.6**	1.6**	1.6‡	1.6♦	1.5	1.5	1.5	1.5	1.8
Fits Waveguide Size, Nom. O.D. (in):					1x½ (WR90)	0.850x0.475 (WR75)	0.702x0.391 (WR62)	½x¼ (WR42)	0.360x0.220 (WR28)
Length (in/mm):	10⅞/276	7⅞/183	10⅞/274	7⅞/187	5⅞/136	4⅞/114	3⅞/94	2⅞/64	1⅞/42
Shipping Weight (lbs/kg):	2/0,9	2/0,9	2/0,9	1/0,45	2/0,9	1/0,45	1/0,45	½/0,23	½/0,23

BANDPASS FILTERS

NOTCH FILTER

Model:	8430A	8431A	8432A	8433A	8434A	8435A	8436A	8439A Δ
Passband Frequency (GHz):	1-2	2-4	4-6	6-8	8-10	4-8	8-12.4	
Maximum Passband Attenuation (dB):	2	2	2	2	2	2	2	
Below Passband Minimum Rejection (dB):	50 ≤ 0.8GHz	50 ≤ 1.6 GHz	50 ≤ 3.5 GHz	50 ≤ 5.5 GHz	50 ≤ 7.5 GHz	50 ≤ 3.2 GHz	50 ≤ 6.9 GHz	
Above Passband Minimum Rejection (dB):	45 2.2-20 GHz	45 4.4-20 GHz	45 6.5-20 GHz	45 8.5-20 GHz	45 10.5-17 GHz	45 8.8-20 GHz	45 13.5-17 GHz	
Dimensions (in/mm):	5⅞x4⅞x1 (140x121x25)	5⅞x3x1 (140x76x25)	4⅞x2x1 (114x51x25)	4x1⅞x1 (102x38x25)	4⅞x1x1 (118x25x25)	3⅞x1⅞x1 (92x45x25)	2⅞x1x1 (73x25x25)	7⅞x3x1 (192x76x25)
Shipping Weight (lbs/kg):	3/1,4	3/1,4	2/0,9	2/0,9	2/0,9	2/0,9	2/0,9	1⅞/0,8

Connectors for all coaxial models: Type N, one male, one female.

* Circular flange adapters available: K-band, HP 11515A; R-band, HP 11516A. See Accessories section, page 53

† Measured below 0.9 times cut-off frequency.

◊ Measured at 1.25 times cut-off frequency.

** Measured to within 100 MHz of cut-off frequency.

‡ Measured to within 200 MHz of cut-off frequency.

♦ Measured to within 300 MHz of cut-off frequency.

Δ Unit is 2 MHz bandwidth Notch Filter with 60 dB attenuation at a rejection frequency of 2 GHz.

features:

MATCHED AT ALL ATTENUATIONS
GREATER THAN OCTAVE BAND COVERAGE
LOW INSERTION LOSS
HIGH ISOLATION

uses:

Amplitude and Pulse Modulate Sources
With Minimum Incidental FM
Level Load Sensitive Sources Without
Frequency Pulling
Switch to High Isolation, Preserving
Good Match

MODULATORS

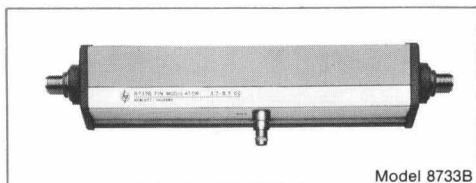

Model 8733B

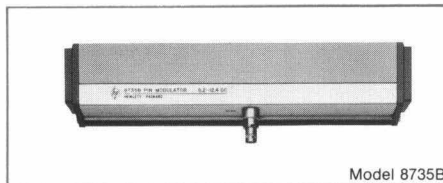

Model 8735B

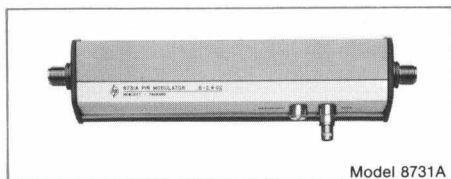

Model 8731A

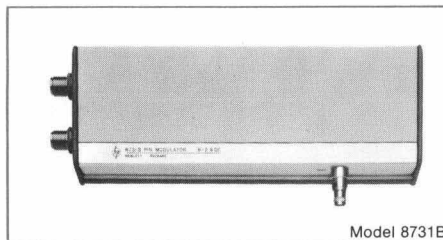

Model 8731B

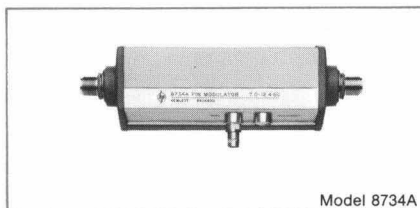

Model 8734A

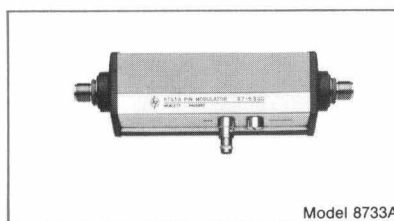

Model 8733A

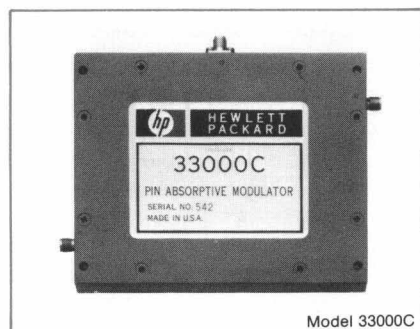

Model 33000C

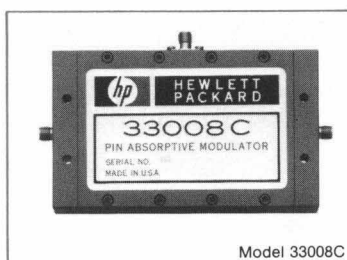

Model 33008C

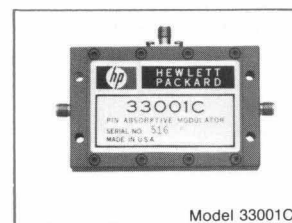

Model 33001C



SPECIFICATIONS

Model:	8731A	8731B	H01-8731B*	8732A	8732B	8733A	8733B	8734A	8734B
Frequency Range (GHz):	0.8-2.4	0.8-2.4	0.4-0.9	1.8-4.5	1.8-4.5	3.7-8.3	3.7-8.3	7.0-12.4	7.0-12.4
Dynamic Range (dB):	35	80	35	35	80	35	80	35	80
Maximum Residual Attenuation (dB)†:	1.5	2.0	2.0	2.0	3.5, 1.8-4.4, 4.5	2.0	3.0	4.0	5.0
SWR, Minimum Attenuation:	1.5	1.6	1.25 ◊	1.5	1.6, 1.8-2.0, 4.5	1.8	2.0	1.8	2.0
SWR, Maximum Attenuation:	1.8	2.0	1.5 ◊	1.8	2.0	2.0	2.2	2.0	2.2
Typical Rise Time (nsec)**:	40	30	40	40	30	30	30	30	30
Typical Decay Time (nsec)**:	30	20	30	30	20	20	20	20	20
Forward Bias Input Resistance (ohms):	300	100	300	300	100	300	100	300	100
Maximum RF Input Power (ave. or peak):	1 W	1 W	1 W	1 W	1 W	1 W	1 W	1 W	1 W
Maximum Bias Voltage Limits (volts):	-10 to +20	-10 to +20	-10 to +20	-10 to +20	-10 to +20	-10 to +20	-10 to +20	-10 to +20	-10 to +20
Leakage:	‡	‡	‡	‡	‡	‡	‡	‡	‡
Connectors:	Type N	Type N	Type N	Type N	Type N	Type N	Type N	Type N	Type N
Dimensions (in/mm):	1 1/8 x 3 1/4 x 2 1/4 (283 x 83 x 57)	1 1/8 x 4 7/8 x 2 1/4 (289 x 124 x 57)	1 1/8 x 4 7/8 x 2 1/4 (289 x 124 x 57)	1 1/8 x 3 1/4 x 2 1/4 (283 x 83 x 57)	1 1/8 x 4 7/8 x 2 1/4 (289 x 124 x 57)	8 3/4 x 3 1/4 x 2 1/4 (213 x 83 x 57)	12 1/4 x 3 1/4 x 2 1/4 (311 x 83 x 57)	8 3/4 x 3 1/4 x 2 1/4 (213 x 83 x 57)	12 1/4 x 3 1/4 x 2 1/4 (311 x 83 x 57)
Weight (lbs/kg):	3/1.4 5/2.2	6/2.7 8/3.6	6/2.7 8/3.6	3/1.4 5/2.2	6/2.7 8/3.6	3/1.4 4/1.8	3/1.4 5/2.3	3/1.4 4/1.8	3/1.4 5/2.3

* External high-pass filters required.

† Residual Attenuation is also referred to as Insertion Loss; measured with +5 volts bias.

◊ Excluding high-pass filters.

** Driven by HP 8403 Modulator. Refer to HP general Catalog for details on this instrument.

‡ Radiated leakage limits are below those specified in MIL-I-6181D at input levels less than 1 mW; at all input levels radiated interference is sufficiently low to obtain rated attenuation.



SPECIFICATIONS

Model:	8735A	8735B	33000C	33000D	33001C	33001D	33008C	33008D
Frequency Range (GHz):	8.2-12.4	8.2-12.4	1-4	1-4	8-18	8-18	3.7-8.0	3.7-8.0
Dynamic Range (dB):	35	80	35, 1-2 GHz 40, 2-4 GHz	65, 1-2 GHz 80, 2-4 GHz	45	80, 8-12 GHz 70, 12-18 GHz	45	80
Maximum Residual Attenuation (dB)*:	4.0†	5.0†	1.8, 1-2 GHz 2.5, 2-4 GHz	2.0, 1-2 GHz 3.0, 2-4 GHz	3.0, 8-12 GHz 3.2, 12-15 GHz 4.3, 15-18 GHz	3.0, 8-12 GHz 3.5, 12-15 GHz 4.5, 15-18 GHz	2.3	2.5
SWR, Minimum Attenuation:	1.7	2.0	1.86	1.86	2.2	2.2	2.2	2.2
SWR, Maximum Attenuation:	2.0	2.2	1.86	1.86	2.2	2.2	2.2	2.2
Typical Rise Time (nsec)	30 ◊	30 ◊	50	50	50	50	50	50
Typical Decay Time (nsec)	20 ◊	20 ◊	50	50	50	50	50	50
Forward Bias Input Resistance (ohms):	300	100	1 typ.	1 typ.	1 typ.	1 typ.	1 typ.	1 typ.
Maximum RF Input Power	1 W ave.	1 W ave.	2 W ave. 100 W peak	2 W ave. 100 W peak	2 W ave. 100 W peak	2 W ave. 100 W peak	2 W ave. 100 W peak	2 W ave. 100 W peak
Maximum Bias Voltage Limits (volts):	-10 to +20	-10 to +20	-2 to +50	-2 to +50	-2 to +50	-2 to +50	-2 to +50	-2 to +50
Leakage:	**	**	‡	‡	‡	‡	‡	‡
Connectors:	WG (See below)	WG (See below)	SMA female	SMA female	SMA female	SMA female	SMA female	SMA female
Fits Waveguide Size, Nom. O.D. (in): (EIA)	1x½ (WR90)	1x½ (WR90)						
Dimensions (in/mm):	6¼x3¼x2¼ (171x83x57)	10½x3¼x2¼ (267x83x57)	5⅞x4¼x¾ (137x108x16)	5⅞x4¼x¾ (137x108x16)	3⅞x2¾x¾ (94x60x16)	3⅞x2¾x¾ (94x60x16)	5x3x¾ (127x76x16)	5x3x¾ (127x76x16)
Weight (lbs/Kg):	Net 3/1,4 Shipping 4/1,8	3/1,4 5/2,3	1.1/0,5	1.1/0,5	0.4/0,19	0.4/0,19	0.75/0,33	0.75/0,33

* Residual Attenuation is also referred to as Insertion Loss.

‡ Measured with +5 volts bias.

◊ Driven by HP 8403 Modulator. Refer to HP general Catalog for details on this instrument.

** Radiated leakage limits are below those specified in MIL-I-6181D at input levels less than 1 mW;
at all input levels radiated interference is sufficiently low to obtain rated attenuation.

‡ Level of RF signal appearing at the bias port is typically 50 dB below the level of signals applied to either RF port.

OTHER DEVICES

- phase shifters
 - waveguide shorting switch
 - coaxial switches
 - frequency doubler
-



PHASE SHIFTERS

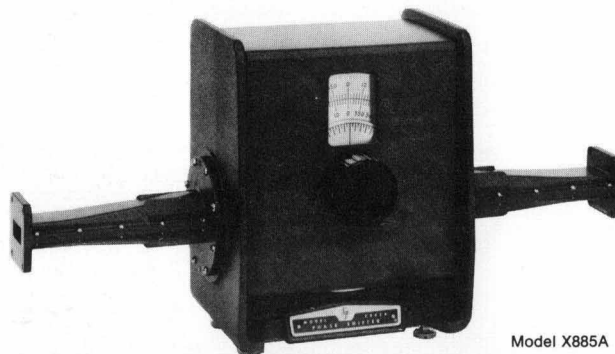

Model X885A

SPECIFICATIONS

Model:	J885A	X885A	P885A
Frequency Range:	5.3 to 8.2 GHz	8.2 to 12.4 GHz	12.4 to 18 GHz
Differential Phase Angle Range:	-360° to +360°. Can be shifted continuously through any number of cycles.	-360° to +360°. Can be shifted continuously through any number of cycles.	-360° to +360°. Can be shifted continuously through any number of cycles.
Accuracy:	± 3° or 10% of phase difference in degrees, whichever is less.	± 3° or 10% of phase difference in degrees, whichever is less; ± 2° or 10% of phase difference in degrees, whichever is less, 8.2 to 10 GHz.	± 4° or 10% of phase difference in degrees, whichever is less.
Insertion Loss:	Less than 2 dB	Less than 1 dB, 8.2 to 10 GHz Less than 2 dB, 10 to 12.4 GHz	Less than 3 dB
Insertion Loss Variation With Frequency: (Fixed phase setting.)	Approximately 1 dB	Approximately 1 dB	Approximately 1 dB
Insertion Loss Variation With Phase Setting: (Fixed frequency setting.)	Less than 0.4 dB	0.3 dB or less, 8.2 to 10 GHz 0.4 dB or less, 10 to 12.4 GHz	Less than 0.5 dB
SWR:	1.35 max.	1.35 max.	1.35 max.
Power Rating:	10 watts	10 watts	5 watts
Fits Waveguide Size Nominal O.D. (in): EIA:	1½ x ¾ WR 137	1 x ½ WR 90	0.702 x 0.391 WR 62
Dimensions Length: Height: Depth:	25¼ in. (638 mm) 8 in. (203 mm) 6¼ in. (159 mm)	15½ in. (397 mm) 7¾ in. (197 mm) 5⅝ in. (138 mm)	12 ⅝ in. (312 mm) 7¾ in. (197 mm) 5 ⅝ in. (138 mm)
Weight Net: Shipping:	14 pounds (6,3 kg) 25 pounds (11,3 kg)	8 pounds (3,6 kg) 10 pounds (4,5 kg)	7 pounds (2,5 kg) 10 pounds (4,5 kg)



X930A WAVEGUIDE SHORTING SWITCH

Reflection Coefficient: <0.01 (1.02 SWR, 40 dB return loss) in "open" position; >0.984 (125 SWR, 0.14 dB return loss) in "short" position.

Insertion Loss: Less than 0.05 dB in "open" position.

Fits Waveguide Size:

Nominal O.D. (in.): 1 x 1/2.
EIA: WR 90.

Frequency Range: 8.2-12.4 GHz.

Dimensions (maximum envelope):

Length (flange to flange): 3 1/16 in. (94 mm).
Height: 2 3/8 in. (60 mm).
Width: 4 1/4 in. (108 mm).

Weight: Net, 1 1/4 lbs. (0,6 kg). Shipping, 2 lbs. (0,9 kg).

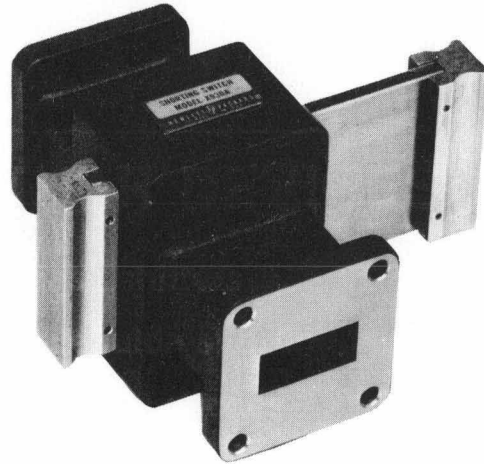

8761A/B COAXIAL SWITCH

Characteristic Impedance: 50 ohms.

Frequency range: dc to 18 GHz.

Standing-wave ratio: looking into one of the connected ports with 50 ohms (or built-in termination) on the other, third port open.

Frequency	Connector type		
	7-mm	N	3-mm (SMA)
dc-12.4 GHz	1.15 (1.20)	1.20 (1.25)	1.25 (1.30)
dc-18 GHz	1.20 (1.25)	1.25 (1.30)	1.30 (1.35)

SWR in parenthesis applies to switch with built-in termination.

These specifications apply when connected ports are of the same connector type; for mixed connector types, the larger of the two VSWR's applies. N-connector VSWR specifications apply to Option 4 connectors.

Insertion loss: <0.5 dB, dc-12.4 GHz; <0.8 dB, dc-18 GHz.

Isolation: >50 dB, dc-12.4 GHz; >45 dB, dc-18 GHz.

Power: safety handles 10W average, 5kW peak, without built-in termination; built-in termination rated at 2W average, 100W peak.

Switching energy: 1.5W for 20 ms (permanent magnet latching).

Solenoid voltages (dc or pulsed): 12-15 V, 8761A; 24-30 V, 8761B.

Switching speed: 35-50 ms (includes settling time).

Life: >1,000,000 switchings.

Dimensions: 1.6 x 1.5 x 1.5 in. (41 x 38 x 38 mm), excluding connectors and solenoid terminals.

Weight: net 5-8 oz (140-220 gm); shipping, 8-11 oz (220-300 gm).

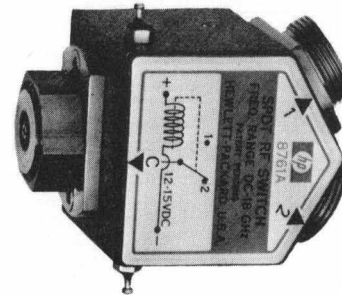

Ordering Information

Specify solenoid voltage and connectors (including built-in 50 ohm termination) by the alphabetic suffix on the switch model number and the appropriate three-digit option number.

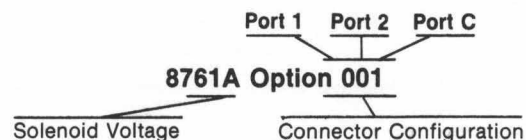

A: 12-15V; B: 24-30V

Option Code	Connector Type	Option Code	Connector Type
0	N Jack	4	7-mm for UT-250 Coax
1	N Plug	5	3-mm Jack
2	7-mm Jack	6	3-mm Plug
3	7-mm Plug	7	50 Termination

"Jack" identifies the connector with fixed threads; "plug" identifies the connector with the coupling nut.



10515 A FREQUENCY DOUBLER



Frequency Range: 0.5-500 MHz input
1-1000 MHz output

Impedance: 50 ohm nominal (source and load)

Input Signal Voltage: 0.5-3.0 V

Input Signal Power: 180 mW (maximum)

Conversion Loss:*
<13 dB (typically <11 dB) for >1 volt
<14 dB (typically <12 dB) for >0.5 volt

Suppression of 1st and 3rd Harmonic of Input:*
>30 dB for 0.5 to 50 MHz input (typically >35 dB)
>10 dB for input to 500 MHz (typically >15 dB)

Dimensions: Diameter: 0.7" (18 mm)
Length: 2.5" (64mm)

Connectors: Input: BNC male
Output: BNC female

Weight: approximately 2 ounces (56 grams)

*With a 50 ohm resistive load and a single input frequency. Suppression values are referred to the desired output level.

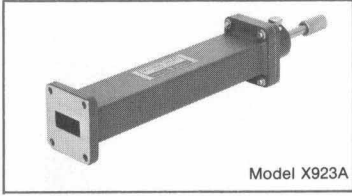

Model X923A

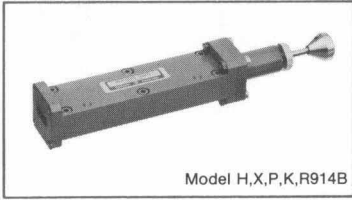

Model H,X,P,K,R914B

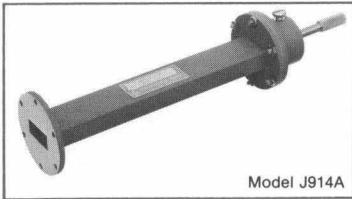

Model J914A

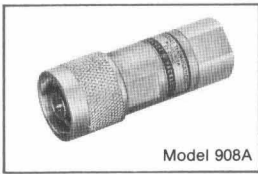

Model 908A

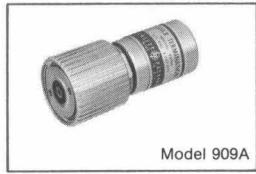

Model 909A

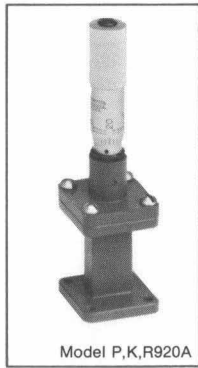

Model P,K,R920A

TERMINATIONS

FIXED AND MOVING
SHORTS AND LOADS

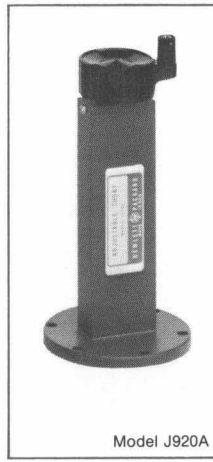

Model J920A

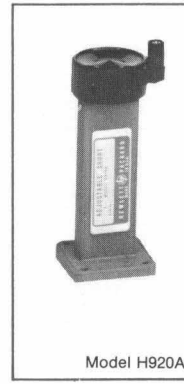

Model H920A

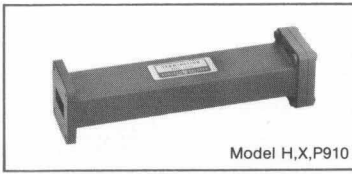

Model H,X,P910

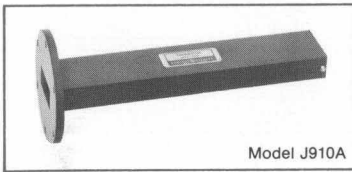

Model J910A

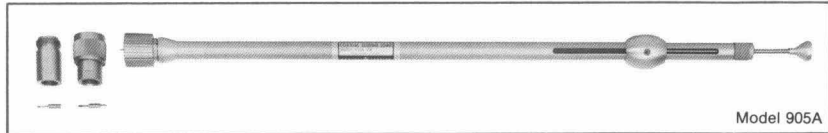

Model 905A

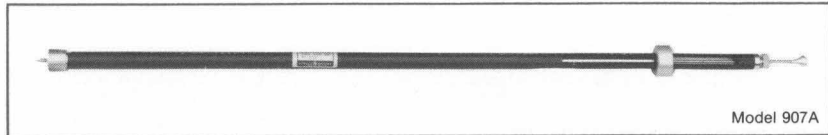

Model 907A

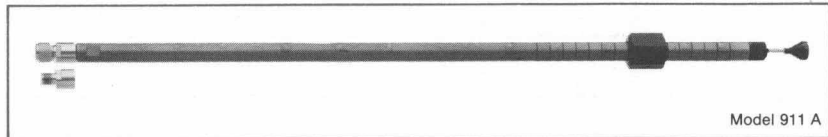

Model 911 A



SPECIFICATIONS

Model:	J910A	H910A	X910B	P910A	J914A	H914A	X914B	P914A
Mode of Operation:	Fixed	Fixed	Fixed	Fixed	Sliding Load	Sliding Load	Sliding Load	Sliding Load
Frequency Range (GHz):	5.30-8.20	7.05-10.0	8.20-12.4	12.4-18.0	5.3-8.2	7.05-10.0	8.2-12.4	12.4-18.0
Maximum SWR:	1.02	1.02	1.015	1.02	1.01	1.01	1.01	1.01
Power Rating:	1 W ave.	1 W ave.	1 W ave.	1 W ave.	2 W ave.	1 W ave.	1 W ave.	½ W ave.
Fits Waveguide Size, Nom. OD (in): (EIA)	1½x¾ (WR137)	1¼x½ (WR112)	1x½ (WR90)	0.702x0.391 (WR62)	1½x¾ (WR137)	1¼x½ (WR112)	1x½ (WR90)	0.702x0.391 (WR62)
Equivalent Flange:	UG-344/U	UG-51/U	UG-39/U	UG-419/U	UG-344/U	UG-51/U	UG-135/U	UG-419/U
Length (in/mm):	8¾/206	5¾/141	6¾/168	4¾/111	15½/394	11½/267	10¾/257	9¾/248
Weight (lbs/kg): Net Shipping	1½/0,67 3/1,4	¾/0,28 1/0,45	¾/0,34 2/0,9	¾/0,17 1/0,45	2¾/1,3 5/2,3	1¼/0,56 2/0,9	¾/0,4 2/0,9	½/0,23 1/0,45

Model:	K914B	R914B	J920A	H920A	P920B	K920B	R920B	X923A
Mode of Operation:	Sliding Load	Sliding Load	Sliding Short	Sliding Short	Sliding Short	Sliding Short	Sliding Short	Sliding Short
Frequency Range (GHz):	18.0-26.5	26.5-40.0	5.30-8.20	7.05-10.0	12.4-18.0	18.0-26.5	26.5-40.0	8.20-12.4
SWR:	1.01 max	1.01 max	175 min	175 min	100 min	100 min	100 min	125 min
Power Rating:	½ W ave.	½ W ave.						
Fits Waveguide Size, Nom. OD (in):	½x¼ (WR42)	0.360x0.220 (WR28)	1½x¾ (WR137)	1¼x½ (WR112)	0.702x0.391 (WR62)	0.500x0.250 (WR42)	0.360x0.220 (WR28)	1x½ (WR90)
Equivalent Flange:	UG-595/U	UG-599/U	UG-344/U	UG-51/U	UG-419/U	UG-595/U	UG-599/U	UG-135/U
Length (in/mm):	6¾/156	5¾/130	6¾/159	4¾/124	5¾/146	5½/140	4½/114	13/330
Weight (lbs/kg): Net Shipping	¾/0,17 1/0,45	¼/0,11 1/0,45	1½/0,68 3/1,4	1/0,45 2/0,9	¾/0,17 1/0,45	¼/0,11 1/0,45	¼/0,11 1/0,45	¾/0,4 2/0,9
Accessories Available†:	11515A	11516A				11515A	11516A	

† See Accessories Section, page 53



SPECIFICATIONS

Model:	905A	907A	911A	908A	909A	11511A	11512A	11565A	15522A ‡	
Mode of Operation:	Sliding Load	Sliding Load	Sliding Load	Fixed	Fixed	Fixed Short	Fixed Short	Fixed Short	Fixed	
Frequency Range (GHz):	1.8-18	1-18	2-18	DC-4	DC-18	DC-18	DC-18	DC-18	DC-100 MHz	
Maximum SWR:	1.05	1.05, 1.5-18 1.1, 1-1.5	**	1.05	†				1.02	
Power Rating:	1 W ave. 5 KW peak	1 W ave. 5 KW peak	1 W ave. 5 KW peak	½ W ave. 1 KW peak	2 W ave. 300 W peak				¼ W ave.	
Minimum Load Travel:	½ λ @ 1.8 GHz	½ λ @ 1 GHz	½ λ @ 2 GHz							
Connectors:	*	*	◇◇	"N"(m)	APC-7	"N"(f)	"N"(m)	APC-7	BNC	
Length (in/mm):	17¼/440	30%/778	14¾/380	2/51	2/51	1⅜/20	¾/18	1⅝/33	1⅞/28	
Weight (lbs/kg):	Net Shipping	⅞/0,2 2/0,9	2/0,9 14/6,3	⅜/0,08 2/0,9	⅜/0,08 ½/0,2	⅜/0,08 ½/0,2	2⅜/0,06 1½/0,7	⅜/0,08 1½/0,7	⅜/0,08 2/0,9	⅞/0,14
Accessories Furnished:	◇	◇	◇							
Options Available:					012, 013				002, 003	

* Interchangeable connector bodies and center pins for use with APC-7 and Type N male and female connectors (two of each type pin supplied).

◇ Carrying case and wrench for changing connector bodies.

† 909A: 1.05 SWR, DC-4 GHz; 1.1 SWR, 4-12.4 GHz; 1.25 SWR, 12.4-18 GHz. 909A Options 012 and 013: 1.06 SWR, DC-4 GHz; 1.11 SWR, 4-12.4 GHz; 1.30 SWR, 12.4-18 GHz.

** 1.1 SWR, 2-4 GHz; 1.07 SWR, 4-8 GHz; 1.05 SWR, 8-18 GHz.

◇◇ Interchangeable connector bodies and center pins for use with SMA plug and jack (two of each type pin supplied).

‡ Characteristic Impedance: 75Ω.

Options: 002 Siemens 2.5mm connector.

003 Siemens 1.6mm connector.

012 Furnished with Type N male connector.

013 Furnished with Type N female connector.

- **adapters**

WAVEGUIDE-TO-WAVEGUIDE,
WAVEGUIDE-TO-COAX, COAX-TO-COAX

- **waveguide clamps & stand**

- **cable assemblies**

- **airlines**

- **rotary joints**

- **flexible waveguides**

- **transistor fixtures**

- **bias tees**

- **APC-7 connector service kit**

ACCESSORIES



ADAPTERS

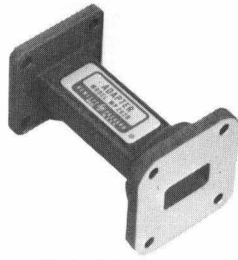

Model X/P/K292 A



Model H/X/P281A

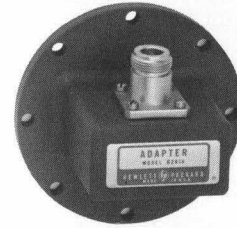

Model S/G/J281A

Model:	S281A	G281A	J281A	H281A	X281A	X281B	P281B	11515A	11516A
Adapter Type:	WG-Coax	WG-Coax	WG-Coax	WG-Coax	WG-Coax	WG-Coax	WG-Coax	Square-Circular Flange	Square-Circular Flange
Frequency Range (GHz):	2.60-3.95	3.95-5.85	5.30-8.20	7.05-10.0	8.20-12.4	8.20-12.4	12.4-18	18.0-26.5	26.5-40.0
Maximum SWR:	1.25	1.25	1.3, 5.3-5.5 1.25, 5.5-8.20	1.25	1.25	1.25	1.25		
Waveguide Size, Nom. O.D.(in)	3x1½ (WR284)	2x1 (WR187)	1½x¾ (WR137)	1¼x¾ (WR112)	1x½ (WR90)	1x½ (WR90)	0.702x0.391 (WR62)		
Coaxial Connector	"N"(f)	"N"(f)	"N"(f)	"N"(f)	"N"(f)	APC-7	APC-7		
Length (in/mm):	5½/140	3¾/95	2/51	1¾/41	1¾/35	1¾/35	2½/64		
Shipping Weight (lbs/kg):	1¾/0,54	0.5/0,27	1/0,45	1/0,45	1/0,45	1/0,45	¾/0,08		
Options Available:						013	013		

Model:	11524A	11525A	11533A	11534A	HX292B	MX292B	MP292B	NP292A	NK292A
Adapter Type:	Coax-Coax	Coax-Coax	Coax-Coax	Coax-Coax	WG-WG	WG-WG	WG-WG	WG-WG	WG-WG
Frequency Range (GHz):	DC-18	DC-18	DC-18	DC-18	8.20-10.0	10.0-12.4	12.4-15.0	15.0-18.0	18.0-22.0
Maximum SWR:					1.05	1.05	1.05	1.05	1.05
Waveguide Size, Nom. O.D.(in)/ Coaxial Connector	APC-7	APC-7	APC-7	APC-7	1¼x¾ (WR112)	0.850x0.475 (WR75)	0.850x0.475 (WR75)	0.590x0.335 (WR51)	0.590x0.335 (WR51)
Waveguide Size, Nom. O.D.(in)/ Coaxial Connector:	"N"(f)	"N"(m)	SMA (m)	SMA (f)	1x½ (WR90)	1x½ (WR90)	0.720x0.391 (WR62)	0.720x0.391 (WR62)	½x¼ (WR42)
Length (in/mm):	1½/38	1¾/45	1¼/32	1¼/32	1½/38	2¾/60	2¾/60	2¾/60	2¾/60
Shipping Weight (lbs/kg):	¼/0,11	¾/0,14	¾/0,14	¾/0,14	¾/0,20	¾/0,25	¾/0,20	¾/0,17	¾/0,14

Option: 013 Furnished with stainless steel Type N female connector.



WAVEGUIDE STAND AND CLAMPS

11540A Waveguide Stand

HP 11540A Waveguide Stands are cast and machined from zinc alloy. They are designed for 11541A through 11548 A Waveguide Clamps and lock the clamps at any height from 2 $\frac{3}{4}$ " to 5 $\frac{1}{4}$ " (70 to 133 mm). The 11540A is 2 $\frac{1}{2}$ " (64 mm) high, and its base measures 4 $\frac{3}{4}$ " (121 mm) in diameter. Shipping weight, 1 lb. (0,9 kg).

Waveguide Clamps

These Clamps consist of a plastic molding. They are offered in 7 sizes to fit waveguide equipment covering frequencies from 2.6 to 40.0 GHz. They are designed for use with the 11540A Waveguide Stand, and when mounted in the stand can be adjusted upward or downward to conform with a waveguide set-up.

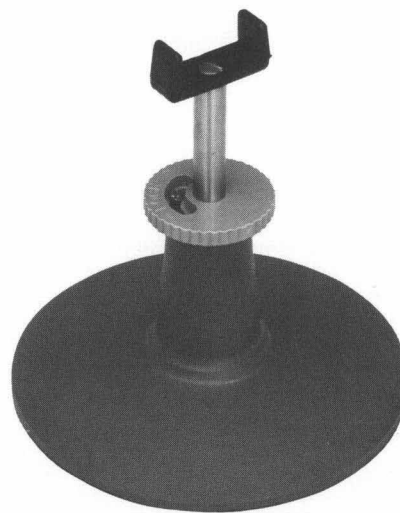

Model	HP Waveguide Designation	Waveguide Size		Shipping Wt.	
		Nom. O.D. (in.)	EIA	(oz)	(g)
11542A	G	2 x 1	WR 187	8	220
11543	J	1 $\frac{1}{2}$ x $\frac{3}{4}$	WR 137	8	220
11544A	H	1 $\frac{1}{4}$ x $\frac{5}{8}$	WR 112	8	220
11545A	X	1 x $\frac{1}{2}$	WR 90	8	220
11546A	P	0.702 x 0.391	WR 62	8	220
11547A	K	$\frac{1}{2}$ x $\frac{1}{4}$	WR 42	8	220
11548A	R	0.360 x 0.220	WR 28	8	220

CABLE ASSEMBLIES, AIRLINES, JOINTS, AND FLEXIBLE WAVEGUIDES

10501A Cable Assembly

44" of 50 coaxial cable terminated on one end only with UG-88C/U BNC male connector.



10502A Cable Assembly

9" of 50 coaxial cable terminated on both ends with UG-88C/U BNC male connectors.

10503A Cable Assembly

4' of 50 coaxial cable terminated on both ends with UG-88C/U BNC male connectors.

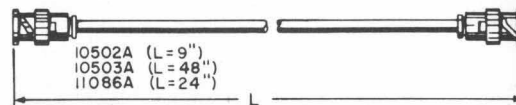

11086A Cable Assembly

24" of 50 coaxial cable terminated on both ends with UG-88C/U BNC male connectors.

11500A Cable Assembly

6' of specially treated 50 coaxial cable terminated on both ends with UG-21D/U Type N male connectors.

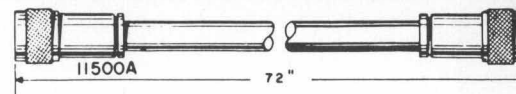

11501A Cable Assembly

6' of 50 coaxial cable terminated with UG-21D/U Type N male and UG-23D/U Type N female connectors.

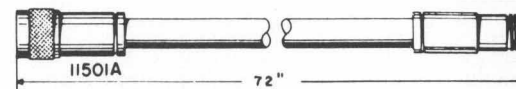

11606A Coaxial Rotary Air Line

Frequency Range: dc to 12.4 GHz.

SWR: <1.1

Insertion Loss: <0.5 dB.

Uncertainty Vector: -57 dB (due to rotation).

Connectors:¹ One 7-mm plug and one 7-mm jack.

Dimensions: 3¹⁵/₁₆ in. x 3/4 in. x 3/4 in. (100 x 19 x 19 mm).

Net Weight: 5¹/₂ oz (154 gm).

Shipping Weight: 1 lb (0,45 kg).

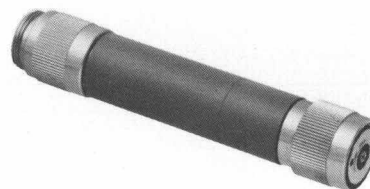

11588A Coaxial Rotary Joint

Frequency Range: dc to 12.4 GHz.

SWR: <1.1

Insertion Loss: <0.5 dB.

Uncertainty Vector: -57 dB (due to rotation).

Connectors: One precision 7-mm jack and one standard APC-7.

Dimensions: 1⁵/₈ in. x 2⁵/₁₆ in. x 1³/₁₆ in. (42 x 59 x 30 mm).

Net Weight: 8 oz (224 gm).

Shipping Weight: 10 oz (280 gm).

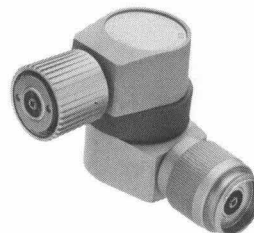

¹Combinations of standard APC-7, Type N, and miniature OSM-type connectors are available; prices on request.



11605A Flexible Arm

Impedance: 50 ohms.
Reflection Coefficient of Ports: ≤ 0.11 (1.25 SWR), DC to 12.4 GHz.
Connectors: Hybrid, APC-7*
Insertion Loss: ≤ 2.5 dB, DC to 12.4 GHz.
Weight: 4 lb (1,8 kg) net.
Length: 10.1 in. (256,5 mm) closed, 25.5 in. (647,7 mm) extended.

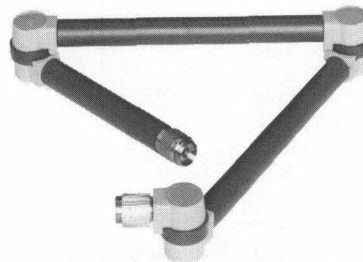

11675A Leveling Cable Assembly

Length: 6 ft (1828,8 mm).
Construction: RF (RG-214) cable and leveling cable covered with single sheath.
Connectors: Male BNC's for leveling cable, Male Type N for RF cable.

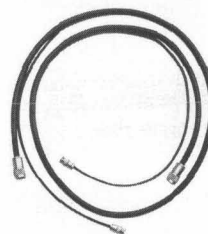

11503A Flexible Waveguide

Frequency: 12.4-18.0 GHz.
Typical VSWR: 1.1
Connectors: WR-62.
Length: 12 inches (305 mm)
Weight: 1/2 lb (0,45 kg) net.



11504A Flexible Waveguide

Frequency: 8.2-12.4 GHz.
Typical VSWR: 1.1
Connectors: WR-90.
Length: 12 inches (305 mm).
Weight: 1 lb (0,90 kg) net.



11566A Airline Extension

Impedance: 50 ohms.
Frequency: DC-18 GHz.
Reflection Coefficient: $.018 + .001$ (freq. in GHz).
Connectors: APC-7.
Length: 10.25 cm.
Weight: 1/2 lb (0,45 kg) net.



11567A Airline Extension

Impedance: 50 ohms.
Frequency: DC-18 GHz.
Reflection Coefficient: $.018 + .001$ (freq. in GHz).
Connectors: APC-7.
Length: 20.25 cm.
Weight: 1/2 lb (0,45 kg) net.



* Registered trademark, Amphenol RF Division, Danbury, Connecticut



TRANSISTOR FIXTURES



Model 11600B 11602B



Model 11608A

Model:	11600B	11602B	11608A**
Package Types	T0-18/T0-72*	T0-5/T0-12†	Microstrip ◇
Frequency Range:	DC-2 GHz	DC-2 GHz	DC-12.4 GHz
Lead Lengths:	up to 1.5 inches	up to 1.5 inches	
Lead Diameters:	0.016 to 0.019 inch	0.016 to 0.019 inch	
Impedance:	50Ω ± 2 Ω	50Ω ± 2 Ω	50Ω ± 2 Ω
Connectors:	APC-7	APC-7	APC-7
Maximum Power:	10 W	10 W	10 W
Dimensions (in/mm):	4½x6x1½ (119x152x38)	4½x6x1½ (119x152x38)	5½x3½x1 (143x89x25)
Weight (lbs/kg):	2½/1,1	2½/1,1	1¾/0,37
Options Available:	001	001	001, 002, 003

* Unit has four snap-on dials, two for bipolars and two for FET's.

† Unit has two snap-on dials for bipolars.

◇ Stripline width: 0.082 inch; material: PPO-0.031 inch thick.

** Must specify one option when ordering.

Options: 11600B/11602B; 001 Precision Type N connectors for input and output.

11608A; 001 Includes blank grounding and clamping inserts for custom machining.

002 Accepts T0-51 package (0.250" dia.).

003 Accepts H-Pac 200 package (0.205" dia.).

All units, except 11608A, opt 001 are supplied with a short circuit termination calibrator and a 50 Ω through line calibrator.

MISCELLANEOUS

BIAS NETWORKS

SPECIFICATIONS	11589A	11590A
Frequency Range (GHz):	.1-3	1-12.4
Maximum SWR:	1.2	1.2
Maximum Insertion Loss (dB):	0.8	0.8
Maximum Power:	50 W	50 W
Maximum Bias Current:	1 A	1 A
RF Connectors:	Type N	Type N
Option Available:	001	001

Option 001 APC-7 connectors.

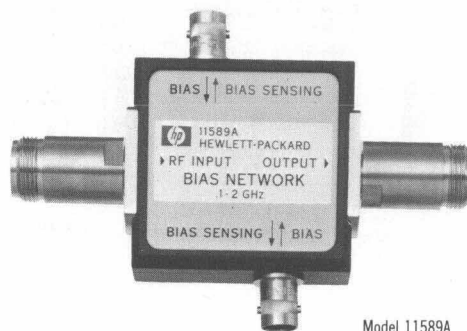

Model 11589A

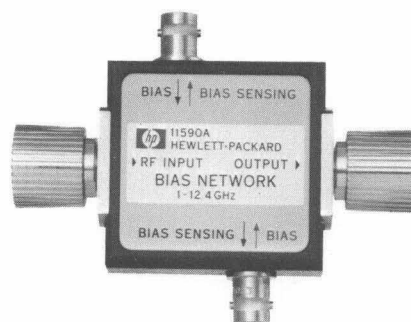

Model 11590A

APC-7 CONNECTOR SERVICE KIT

Item No.	Quantity	Description	Use
1	1	Contact Extractor Tool	Inner conductor contact removal
2	1	Face Spanner Wrench	Coupling assembly removal, replacement
3	2	Open-end Wrench	Coupling assembly removal, replacement Connector removal, replacement
4	5	Inner Conductor Contact	Replacements for damaged contacts
5	2	Pin Vise	Inner conductor contact holder removal, replacement





WAVEGUIDE INSTRUMENTATION

Instrument Name	Uses	Family Model Number	Frequency coverage by band—GHz									
			S 2.6-3.95	G 3.95-5.85	J 5.30-8.20	H 7.05-10.0	X 8.20-12.4	M 10.0-15.0	P 12.4-18.0	K 18.0-26.5	R 26.5-40.0	
Adapters	Interconnect coaxial-waveguide systems	281A	X	X	X	X	X					
	Interconnect two different waveguide systems	281B 292A 292B					X X X		X	X		
Low-pass filters	Output filters for signal sources to eliminate harmonics	362A					X	X	X	X	X	
Variable attenuators	Measurement of reflection coefficient, insertion loss, transfer characteristics by RF substitution; reduction of power levels; reduction of source mismatch	382A	X		X	X	X			X	X	X
		375A					X			X		
Crystal Detectors	RF detection; reflection coefficient, attenuation measurements	424A 422A	X	X	X	X	X	X	X		X	X
Detector mount	Tunable detector mount for accurate matching of waveguide sections to crystal or bolometer	485B					X					
Frequency meters	Frequency measurements	532A 532B			X	X	X			X	X	X
Directional couplers	Power measurements; power leveling; reflection measurements; isolation	752A			X	X	X			X	X	X
		752C			X	X	X			X	X	X
		752D			X	X	X			X	X	X
Slotted line systems	Measurement of SWR, wavelength, impedance; fixed and swept-frequency slotted line measurements	810B 815B			X	X	X			X	X	X
PIN modulators	Sinusoidal and complex AM and RF pulsing of microwave sources without incidental FM	8735A 8735B					X X					
Fixed and sliding loads	Fixed loads for terminating waveguide systems, Sliding loads for separating load reflections from other system reflections	910A			X	X				X		
		910B			X	X	X			X		
		914A			X	X	X				X	X
		914B					X					
Fixed and sliding shorts	Establish measurement planes, reflection phase and magnitude references	920A			X	X				X	X	X
		920B								X		
		923A					X					
Shorting switches	Establish removable short circuit in waveguide system	930A					X					
Mixers	Harmonic Mixer	923A							X			
Slide screw tuners Phase shifters	Correct discontinuities in waveguide Provide phase control	870A			X		X			X		
		885A					X			X		

¹ Instrument model number consists of family model number prefixed by letter of waveguide band, E.G., X281B specifies X-band waveguide to coax adapter.



COAXIAL INSTRUMENTATION

Instrument name	Uses	Frequency coverage by model													
		dc	10 MHz	100 MHz	215 MHz	450 MHz	500 MHz	940 MHz	1 GHz	2 GHz	3 GHz	4 GHz	10 GHz	12.4 GHz	18 GHz
Directional couplers	Power measurements; power leveling; reflection measurements; isolation								← 796D →		← 779D →				
Slotted line system Slotted section Swept slotted line system	Measurement of SWR, wavelength, impedance; fixed and swept-frequency slotted line measurements								← 805C →			← 816A →	← 817A →		
Fixed and sliding loads	Fixed loads for terminating 50-ohm systems (908A, 909A) Sliding loads for separating load reflections from other system reflections (905A, 907A, 911A)					← 908A →		← 909A →			← 905A →	← 907A →			
PIN modulators	Sinusoidal and complex AM and RF pulsing of microwave sources without incidental FM							← 8731B, Opt. H10 →	← 8731A, B →		← 8732A, B →	← 8733A, B →	← 8734A, B →		
										← 33000C, D →		← 33001C, D →	← 33008C, D →		
Mixers	Mixing SHF and VHF signals											← 934A →			
													← 33800 Series →		
Transistor fixtures	Make RF, dc connections to solid state devices														
Bias networks	Apply dc bias to solid state devices in RF measuring systems														
Coaxial switches	Electrically switch RF signals														
Air lines	Adapt test equipment port spacing to devices under test														
Shorts	Establish measurement planes, reflection phase and magnitude references														



For more information, call your local HP Sales Office or East (201) 265-5000 • Midwest (312) 677-0400 • South (404) 436-6181 • West (213) 877-1282. Or, write: Hewlett-Packard, 1501 Page Mill Road, Palo Alto, California 94304. In Europe, Post Office Box 85, CH-1217 Meyrin 2, Geneva, Switzerland. In Japan, YHP, 1-59-1, Yoyogi, Shibuya-Ku, Tokyo. 151.

5952-1120D

PRINTED IN U.S.A.

WWW.HPARCHIVE.COM